



FULL LINE CATALOGUE

TITAN INTERNATIONAL

2025
2026





OUR MISSION

When your business depends on the tools you use, you need to be able to count on the people who make them. Our relentless commitment to helping every professional painter be their best leads to better work, improved ROI and growing business.



All information contained in this brochure is based on the latest information available at the time of printing. TITAN reserves the right to make changes at any time, without notice. Due to continuous innovation, specifications may progressively change. Contact one of our dependable sales reps or call our dedicated customer service team for more information.

FULL LINE CATALOGUE

TITAN INTERNATIONAL

01 FOCUS

Versatility and control combined in one fine sprayer. The multitools for painters.

02 FLEXPSPRAY

The next generation of hand-held spraying systems with battery technology for even more freedom.

03 CAPSPRAY

Maximize productivity and profit with these light-weight, portable sprayers.

04 ELITE

Lightweight, sprayer, for small to medium sized jobs.

05 CONTROLMAX

Powerful and mobile airless sprayer for semi-professional applications.

06 COMPACT

The perfect Entry Level unit for professional painters seeking a very reliable and versatile sprayer.

07 IMPACT

Durable electric airless sprayers built with smart features that make an Impact.

08 IMPACT X

It's the sprayers you love re-engineered to spray faster, smarter, and better on every job, every time.

09 POWRBEAST

Heavy-duty direct immersion sprayer for large-scale jobs.

10 POWRTWIN

For large scale residential, commercial and industrial applications.

11 HYDRA X

Powerful high pressure sprayer with the pressure needed to spray the toughest coatings.

12 POWRLINER

A range of pavement and turf marking equipment for all size projects.

13 POWRMAX

Powerful screw pump for processing highly viscous and heavily filled materials.

14 PROSTEP

Steam wallpaper strippers are the quickest way to remove wallpaper sustainably without chemical additives.

15 ACCESSORIES

TITAN offers a full range of accessories for a full range of applications.

Contact one of our dependable Country Importer or call our dedicated customer service team for more information.

Visit us on the web at: titantool-international.com

Service Department: Customer.Service-PF@wagner-group.com

ADDRESS

J. Wagner GmbH
Otto-Lilienthal-Str. 18
88677 Markdorf
Germany



FOCUS

With only one device you are able to spray paints, varnish and even stains. Quick and easy change of materials and paints in just one step. Optimally suited for small and medium sized projects up to 50 m².

While conventional HVLP devices are usually capable of working only with standard paints and varnishes, JetForce systems extend the scope of applications to high-viscosity paints and emulsions.

FOCUS 700

With only one device you are able to spray paints, laquers and even stains. Quick and easy change of materials and paints in just one step. Optimally suited for small and medium sized projects up to 50 m².

10X THE LIFE

Of a hand held airless sprayer

QUICK-CHANGE SYSTEM

Change your coating or application on the fly. Change frontends and material with ease

HIGH PRODUCTIVITY

JetForce Spraying System has the productivity of an airless using a 413 tip

SLOT NOZZLE

Gives better atomization of high viscosity coating materials

WIDE PATTERN

Adjust your spray pattern from 1 to 14 inches and quickly change from a horizontal to vertical pattern with the turn of the nozzle



SPECIFICATIONS	FOCUS 700
Voltage	230 V~, 50 Hz
Power Consumption	1.4 kW
Atomizing Output	300 W
Container Volume	1000 ml
Air Hose	5 m
Power cable	4 m
Weight	8 kg
Scope of delivery	Focus 700 Turbine, MultiFinish Spray Attachment with 5 m Air Hose
PART-NO.	2335642



FLEXSPRAY

FlexSpray Pro 18V more flexible than ever. The powerful AMPShare powered by Bosch battery system gives you freedom of movement without cables.

With just one device you can spray water and solvent-based varnishes, wood stains, undercoats and emulsion paints. Ideal for touch-up and renovation work, small and medium-sized projects up to 50 m².

FLEXSPRAY PRO 18V

The FlexSpray Pro 18V cordless paint sprayer is the ideal partner for achieving perfect results when coating smaller objects or undertaking other painting, repair and renovation work. Thanks to it being cordless, users benefit from being able to work anywhere. The excellent thermal management of the rechargeable batteries in combination with the brushless motor ensures optimised

runtime, a longer service life and optimum atomisation performance. Thanks to the shared battery system, in addition to AMPShare 18V batteries, all Bosch Professional 18V batteries from 2008 onwards can also be used with the tools from the contractor range and participating partner brands.



CONTROL ELEMENT

For an optimum overview (filter warning, air volume regulation and battery indicator)



QUICK CHANGE SYSTEM

Easy switching of spray attachments and materials

BRUSHLESS AND EFFICIENT TURBINE

Powerful, low-maintenance and compact

VIBRATION WARNING

In the handle when the battery status is critical

FINEFINISH PRO SPRAY ATTACHMENT

Low overspray and compact, extra-lightweight design for comfortable work

BOSCH PROFESSIONAL 18V AMPSHARE

Flexibility through one battery system



SPECIFICATIONS	FLEXSPRAY PRO 18V KIT	FLEXSPRAY PRO 18V BARE
Voltage		18V
Power Consumption		370W
Max. Operating Pressure		0.2 bar, 0.02 MPa
Container Volume		1000 ml
Weight		1.9 kg (incl. battery) 1.3 kg (excl. battery)

Scope of delivery	FlexSpray Pro 18V bare unit, FineFinish Pro spray attachment, Bosch AMPShare 4Ah ProCore 18V 2 units, Bosch charger GAL40-18V, Transport case L-Boxx 374 with suspension set, Riser tube filter, Cleaning set	FlexSpray Pro 18V bare unit, FineFinish Pro spray attachment, Riser tube filter, Cleaning set
-------------------	---	---

PART-NO.	2443233	2443232
----------	---------	---------



CAPSPRAY

The Capspray series is the closest you'll come to a turbine-powered paint brush. Featuring the only 6-stage turbine on the market, these HVLP paint sprayers are designed to combine next-level power and extreme agility with the ability to move freely throughout the job site. Here's what makes the Capspray an asset in tackling cabinets, trim, furniture, metal, and more.

The Capspray is a powerful and versatile turbine unit, spraying a wide range of coatings. Sprays stain up to finish quality latex emulsion. Rugged, portable and dependable as you would expect.



OUR PRODUCT HIGHLIGHTS

HIGH-PERFORMANCE AIR FILTERS

- ◆ Automotive-type air filter delivers clean atomizing air and a consistent fan pattern
- ◆ Quick-change dual filtration system requires no tools for both atomizing and cooling air
- ◆ Dirty filter warning light notifies you when it's time to change the air filter



FEATURING ONBOARD TOOLS

- ◆ Built-in cup gun holder
- ◆ Tool box for air caps and projector sets
- ◆ Dirty filter warning light



CAPSPRAY X 80

Are you looking for a cost-effective solution for high-quality surfaces that will impress your customers? Capspray X 80 is the ideal partner: the HVLP paint spraying system applies all common solvent- and water-based paints with perfect coverage and is ideal for medium-sized residential and commercial

projects. In addition, the low-pressure technology of Capspray X 80 minimises spray mist, which saves material and protects the environment. Other advantages include its high performance and lightweight design. The material and air volume can be adjusted directly on the gun to suit the object being coated.

FILTER WARNING LIGHT

Indicates when the filter needs cleaning or replaced

ADJUSTABLE AIR AND MATERIAL VOLUME

Directly on the gun

INTEGRATED STORAGE BOX

Ideal for needles, air caps, tools and cleaning accessories

SPRAY GUN STORAGE

Ideal for work breaks, storage and transport

TWIN AIR FILTERS

Easily accessible filters with large surface for optimal atomisation



SPECIFICATIONS	CAPSPRAY X 80
Voltage	230 V~, 50 Hz
Power consumption	1.15 kW
Max. air ram pressure	0.3 Bar / 0.03 MPa
Weight	6.8 kg
Hose length	7.6 m
Container capacity	1 l
Scope of delivery	Base unit, Capspray X 80, Maxum III HVLP Pro Gun and 7.6 m Air Hose, Cleaning kit
PART-NO.	2439416

CAPSPRAY 105

Larger projects involving heavier-bodied coatings require the 5-stage power and long-term dependability of the Capspray 105, a solid – but remarkably lightweight – workhorse HVLP sprayer capable of atomizing thick latex or solvent-based paints,

enamels or varnishes with little or no thinning. This is the sprayer professionals use when projects expand or workshops fill with cabinets and furniture.

POWERFUL ATOMIZATION

Legendary power delivers the finest atomization for a superior finish

DIRTY FILTER WARNING LIGHT

Extend the life of your turbine and maintain maximum performance with clean filters.

FIVE-STAGE TURBINE

HVLP Spraying System has the productivity of an airless using a 413 tip

DUAL AIR FILTRATION

Atomizing air has a pre-filter and automotive type air filter; turbine cooling air is also filtered

BUILT-IN GUN & CUP HOLDER

For added storage and portability

BUILT-IN TOOLBOX

For needles, nozzles, air caps and nozzle wrench

PRE-FILTER

On both atomizing air and cooling air sides.



SPECIFICATIONS	CAPSPRAY 105
Voltage	230 V~, 50/60 Hz
Max. current consumption	9.0 A
Power consumption	1.8 kW
Max. air ram pressure	21 000 RPM (0.55 bar RPM)
Weight	15 kg
Mains cable	3 m
Container capacity	1 l
Typical coating flow rate	0.35 l/min
Scope of delivery	Capspray 105 HVLP turbine, Maxum II HVLP Gun with Nozzle Set No. 4 (1.8 mm) and 9 m Air Hose
PART-NO.	276047



ELITE

TITAN Elite piston pumps use the revolutionary PermaStroke Technology that has no piston, packings or clutch to replace. The Elite pumps are versatile direct drive sprayers that delivers a consistent finish and is easy to operate and is field serviceable, keeping contractors on the job.

The PermaStroke Technology of TITAN's Elite series is here to ensure you never have to replace your sprayer's piston, packings, cylinder, or clutch. This sprayer is always ready to make your projects look good.

OUR PRODUCT HIGHLIGHTS

SEALED HYDRAULICS

- ◆ No piston or packings, cylinder or clutch to wear or burn out
- ◆ Delivers top performance at pressures from 20 to 270 bar and when using small or large tip sizes
- ◆ Eliminates deadband – delivering a consistent fan pattern optimizing finish quality
- ◆ WearGuard Elite Lifetime Warranty on the fluid pump

SMART DESIGN

- ◆ Roll-bar style cart protects the sprayer from jobsite and vehicle wear and tear
- ◆ Frame version connects with a flexible suction set can also be fitted with a hopper accessory (not Elite 3500) to be used with fine finishing coatings (hopper sold separately)

PERMASTROKE CLOSE UP SERVICE ON THE JOBSITE

- ◆ Quickly field serviceable, change out the cartridge-style inlet and outlet valves in less than 5 minutes with common tools
- ◆ The Sureflo Pusher Valve unsticks the lower ball valve with just a push of a button

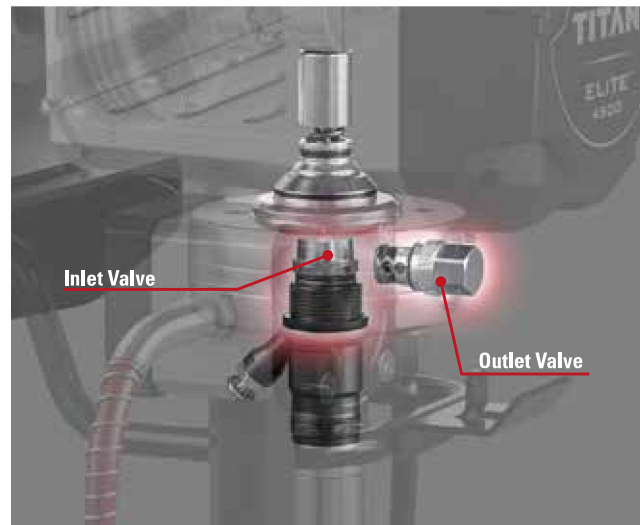

ELITE



ELITE 2000

Good things do come in small packages with the Elite 2000 from TITAN. The most recent offering in TITAN's Elite Series of sprayers features the Elite technology that contractors have trusted for years in a new compact design perfect for Residential, Light

Commercial, and Fine Finish applications. The small unit sprays all standard architectural primers, paints, and coatings.

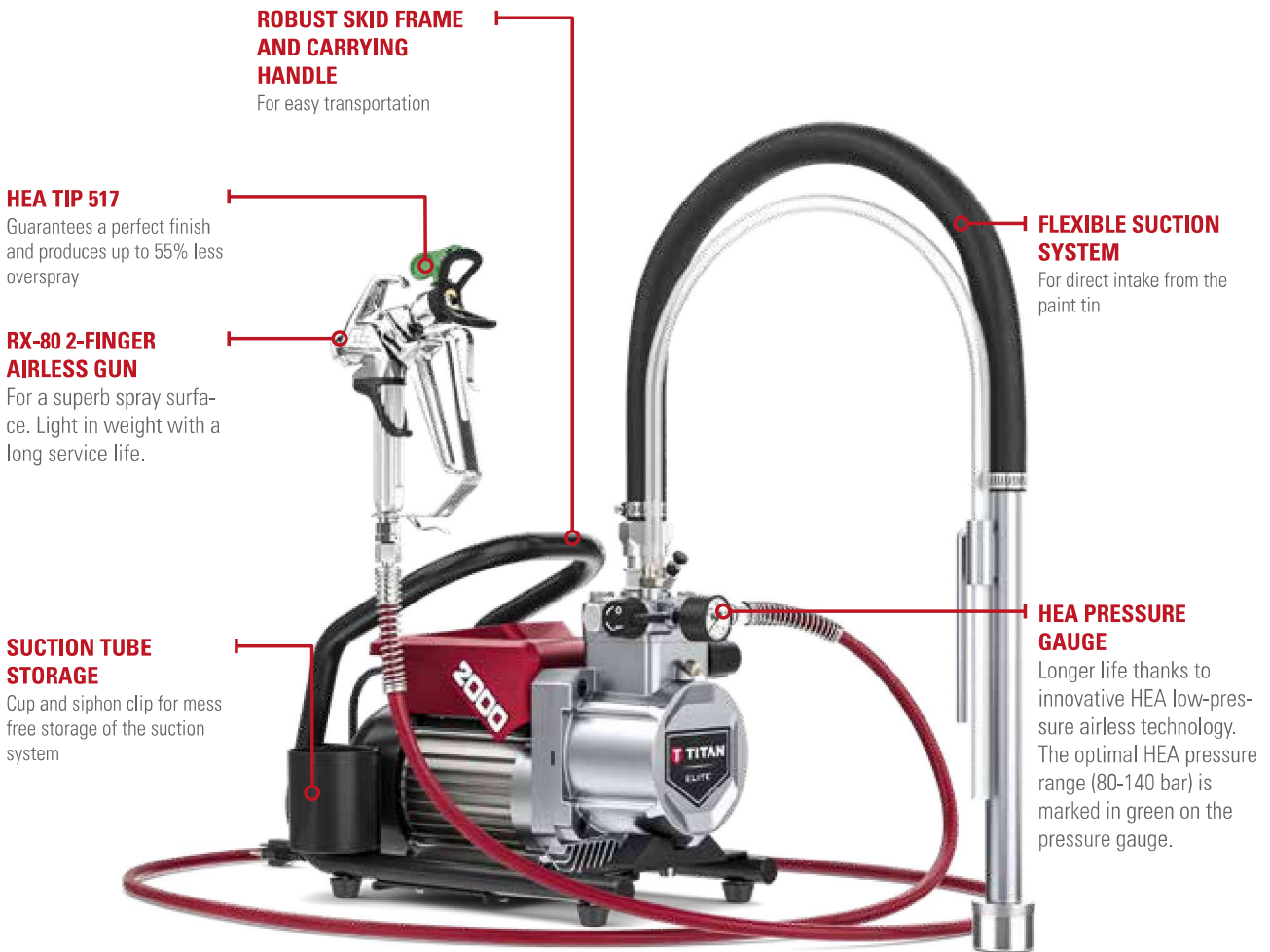

ROBUST SKID FRAME AND CARRYING HANDLE

For easy transportation

HEA TIP 517

Guarantees a perfect finish and produces up to 55% less overspray

RX-80 2-FINGER AIRLESS GUN

For a superb spray surface. Light in weight with a long service life.

FLEXIBLE SUCTION SYSTEM

For direct intake from the paint tin

SUCTION TUBE STORAGE

Cup and siphon clip for mess free storage of the suction system

HEA PRESSURE GAUGE

Longer life thanks to innovative HEA low-pressure airless technology. The optimal HEA pressure range (80-140 bar) is marked in green on the pressure gauge.



SPECIFICATIONS	ELITE 2000
Max. Delivery	2.1 l/min
Max. Tip Size	0.021"
Max. Operating Pressure	207 bar / 20.7 MPa
Max. Viscosity	15000 mPas
Weight	25.4 kg
Engine / Motor	Electric Engine 0.9 kW
Voltage	230 - 240 V ~, 50 Hz
Scope of delivery	Elite 3000 base unit, Flexible Suction System, RX-80 2-Finger Airless Gun, HEA ProTip 517 Tip, 15 m x 1/4" Airless hose
PART-NO.	2474020

ELITE 3100

For everybody looking for a reliable tool on the jobsite which is as versatile as the jobs, the TITAN Elite 3100 is the right choice. It is a diaphragm pump, which fulfills the highest expectations of durability. The robust pump design is versatile and can be changed easily between suction system or hopper.

The Elite 3100 is capable of spraying paint and varnish perfectly. It is easy to use and needs less maintenance and servicing. The valves can be easily accessed and changed - even on the job site.

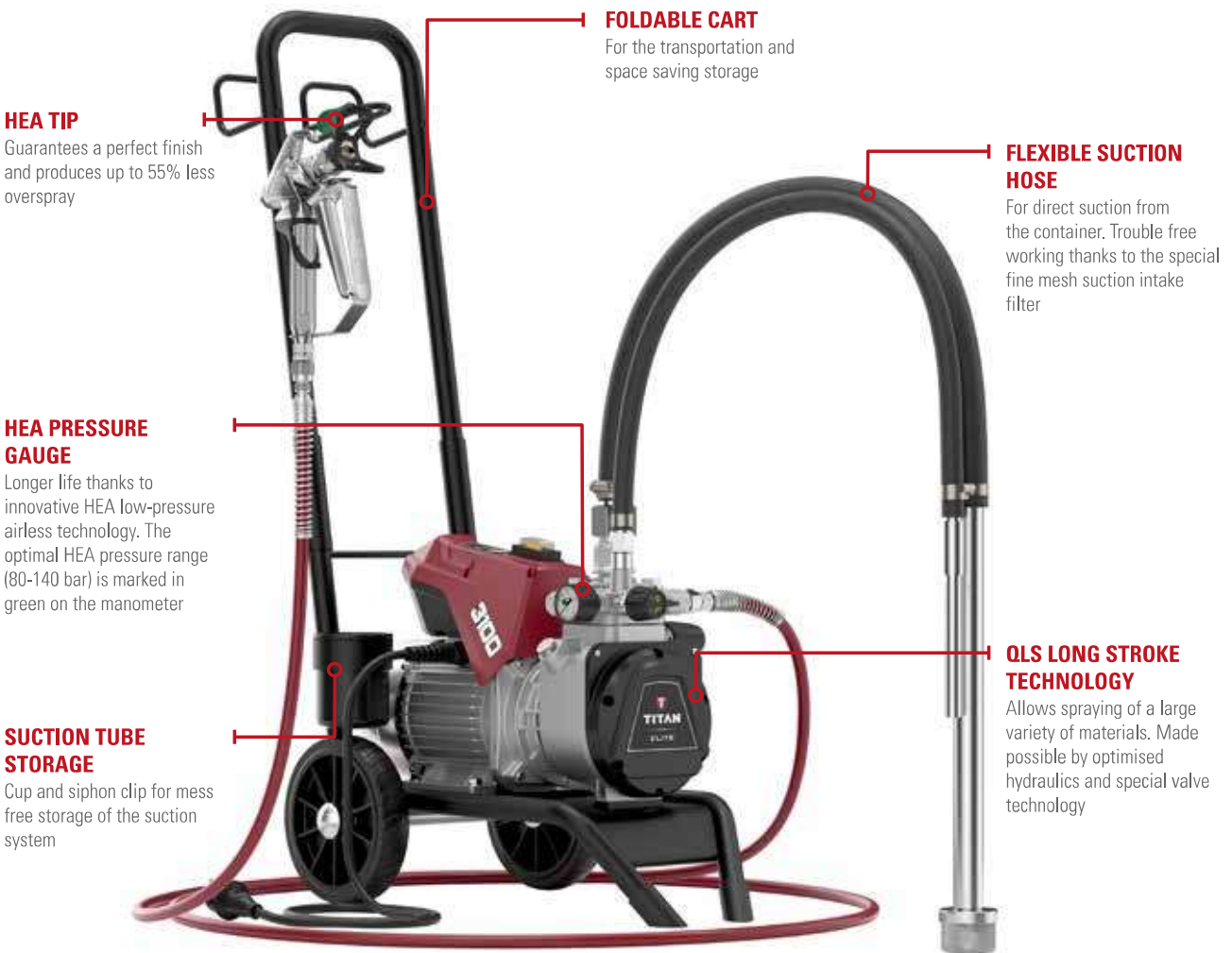

HEA TIP

Guarantees a perfect finish and produces up to 55% less overspray

FOLDABLE CART

For the transportation and space saving storage

FLEXIBLE SUCTION HOSE

For direct suction from the container. Trouble free working thanks to the special fine mesh suction intake filter

HEA PRESSURE GAUGE

Longer life thanks to innovative HEA low-pressure airless technology. The optimal HEA pressure range (80-140 bar) is marked in green on the manometer

OLS LONG STROKE TECHNOLOGY

Allows spraying of a large variety of materials. Made possible by optimised hydraulics and special valve technology

SUCTION TUBE STORAGE

Cup and siphon clip for mess free storage of the suction system



SPECIFICATIONS

ELITE 3100

Max. Delivery	2.6 l/min
Max. Tip Size	0.023"
Max. Operating Pressure	250 bar / 25 MPa
Max. Viscosity	20000 mPas
Weight	27 kg
Engine / Motor	Electric Engine 1.3 kW
Voltage	230 - 240 V ~, 50 Hz

Scope of delivery

Elite 3100 base unit, Flexible Suction System, RX-80 4-Finger Airless Gun, HEA ProTip 517 Tip, 15 m x 1/4" Airless hose

PART-NO.

2432635

ELITE 3500

The TITAN Elite 3500 is a petrol-powered, sealed hydraulic paint sprayer that offers a lifetime of durability. The Elite 3500 uses the revolutionary PermaStroke Technology that has no piston, packings or clutch to replace, and is backed by the Elite lifetime fluid pump warranty.

The Elite 3500 is a versatile direct drive sprayer that delivers a consistent finish and is easy to operate and is field serviceable, keeping contractors on the job.

TELESCOPIC HANDLE WITH HOSE STORAGE

Extends for comfortable job site usage and retracts for transport

PERMASTROKE TECHNOLOGY

- Continuously stroking system eliminates deadband, delivering consistent coverage
- No piston or packings to wear or replace
- One-piece inlet and outlet valves
- 100% field serviceable

NO-SPILL PUMP FILTER

Vertical design retains coating during removal

LARGE 12" PNEUMATIC TYRES

Smoother travel over rough surfaces



Powered by HONDA GX120 ENGINE

- Exceptionally quiet
- Smooth performance with lower vibration
- Low oil alert prevents engine seizure

FLATLINE PULSATION DAMPENER

Eliminates all pressure fluctuations in the system

SUREFLO PUSHER VALVE

Makes system priming easy



SPECIFICATIONS	ELITE 3500
Max. Delivery	2.5 l/min
Max. Tip Size	0.027"
Max. Operating Pressure	228 bar / 22.8 MPa
Max. Viscosity	20000 mPas
Weight	47 kg
Engine / Motor	Honda GX120
Scope of delivery	Elite 3500 base unit, Rigid Suction System, RX-Pro Airless Gun, TR ¹ 517 Tip, 15 m x 1/4" Airless hose
PART-NO.	0537012

ELITE 4300

The Elite 4300 is the reliable tool for large building sites. The diaphragm pump is extremely powerful and can be used with up to 3 guns. At the same time it is capable of spraying a wide range of materials such as interior and exterior paints, as well as fire and rust protection or floor and roof coatings. The robust pump design fulfills the highest expectations of durability and

needs low maintenance. A minimal down time is guaranteed by the easily accessible valves which can be changed even on the construction site. The diaphragm pump can be used with a direct suction system or a hopper and is particularly easy to use thanks to product features such as the HEA Tip and the multi function switch.

HEA TIP

Guarantees a perfect finish and produces up to 55% less overspray



HEA PRESSURE GAUGE

Longer life thanks to innovative HEA low-pressure airless technology. The optimal HEA pressure range (80-140 bar) is marked in green on the manometer



INTEGRATED TOOLBOX

Never miss a tool on the building site again



MODULAR

Two position cart for use with hopper or rigid suction system



TELESCOPIC HANDLE WITH HOSE STORAGE

Extends for comfortable job site usage and retracts for transport



MULTI FUNCTION SWITCH

Multi stage: on/off switch, circulation and spray mode. This prevents accidental switching on or off under pressure



QLS LONG STROKE TECHNOLOGY

Allows to spray a large variety of materials. Made possible by optimised hydraulics and special valve technology



SPECIFICATIONS	ELITE 4300
Max. Delivery	4.3 l/min
Max. Tip Size	0.033"
Max. Operating Pressure	250 bar / 25 MPa
Max. Viscosity	25000 mPas
Weight	50 kg
Engine / Motor	Electric Engine 2.2 kW
Voltage	230 V ~, 50 Hz
Scope of delivery	Elite 4300 base unit, Rigid Suction System, RX-Pro Airless Gun, HEA ProTip 521 Tip, 15 m x 1/4" Airless hose
PART-NO.	2432646



CONTROLMAX

The compact ControlMax airless piston pumps are ideal for getting started with professional spraying. They are suitable for a wide range of indoor and outdoor coating materials and are easy to transport from site to site.

Thanks to the powerful motor, the appliance offers sufficient power for use in private homes or for smaller commercial projects. Ideal for airless beginners or semi-professional users looking for maximum reliability and versatility.

CONTROLMAX 1900

The ControlMax 1900 Pro piston pump with High Efficiency Airless takes the fear out of airless spraying, making it easier to paint like a pro. The HEA system's tip technology decreases overspray by up to 55 percent while delivering a softer spray, improving control and providing a more-consistent finish. The

durable and powerful HEA pump can spray unthinned coatings with a long lasting pump with easy to replace inlet and outlet valves that maximizes sprayer life.



INTEGRATED STORAGE BOX
Ideal for storing tools and accessories

ADJUSTABLE PRESSURE CONTROL FROM TO 110 BAR
For a perfect spray pattern even with differing materials

INLET PUSHER VALVE
For high levels of operating safety and easy start-up. The valve is released with just the press of a finger

DIRECT INTAKE FROM THE PAINT CONTAINER
Enables processing of high-viscose materials

INNOVATIVE HEA TIP TECHNOLOGY
Two tip bores, one directly underneath the other, guarantee a perfect spray pattern with high material throughput even in low pressure ranges

LIGHTWEIGHT AIRLESS GUN WITH TWO-FINGER TRIGGER
For fatigue-free and safe work

PRESSURE GAUGE
Allows the perfect control of pressure in coordination with the material being processed

- **CART VERSION**
- **SKID-VERSION**



SPECIFICATIONS	CONTROLMAX 1900 SKID	CONTROLMAX 1900 CART
Max. Delivery	1.5 l/min	1.5 l/min
Max. Tip Size	0.019"	0.019"
Max. Operating Pressure	110 bar / 11 MPa	110 bar / 11 MPa
Weight	7.6 kg	13 kg
Voltage	230 V ~, 50 Hz	230 V ~, 50 Hz
Scope of delivery	ControlMax 1900 base unit, Rigid Suction System, HEA Pro metall gun, HEA ProTip 311, 515 and 619, DN8 15m airless hose	ControlMax 1900 base unit, Flexible Suction System, HEA Pro metall gun, HEA ProTip 311, 515 and 619, DN8 15m airless hose
PART-NO.	2371077	2371081



COMPACT

High performance airless spray system for residential and light commercial applications. Powerful motor coupled with double acting piston pump provides the performance required for a wide variety of applications.

This is the perfect Entry Level unit for professional painters seeking a very reliable and versatile sprayer.

COMPACT 190

For contractors who need portability, high performance and substantial capacity for monthly spraying in residential and light commercial applications. The double acting piston pump delivers even paint flow on both up and down strokes for a powerful and smooth operation.

DEDICATED HOSE STORAGE

For tidy and compact transport and storage

HEA PRESSURE GAUGE

Longer life thanks to innovative HEA low-pressure airless technology. The optimal HEA pressure range (80-140 bar) is marked in green on the manometer

INLET PUSHER VALVE

Guarantees high reliability. One push and the inlet valve is free

LIGHTWEIGHT CART WITH TOOLBOX

For optimized transportation and storage. Never miss a tool on the building site



AIRLESS HOSE 15 m X 1/4"

For a large working radius

HEA 517 TIP

For a perfect finish and up to 55% less overspray

SUPERB SPRAY SURFACE QUALITY

With RX-80 Airless gun. Light in weight with a long service life

BUILDING SITES OPTIMIZED PRIME/SPRAY SWITCH

For safe and reliable pressure relief

DOUBLE ACTING PISTON - TECHNOLOGY

For smoother running and less wear

DIRECT INTAKE FROM THE PAINT TIN

For fast, clean painting



SPECIFICATIONS	COMPACT 190
Max. Delivery	1.9 l/min
Max. Tip Size	0.019"
Max. Operating Pressure	200 bar / 20 MPa
Weight	18 kg
Engine / Motor	Electric Engine 800 W
Voltage	230 V ~ 50 Hz / 240 V ~ 50 Hz
Scope of delivery	Compact 190 base unit, RX-80 Gun, HEA Pro Tip 517, 15 m x 1/4" Airless hose
PART-NO.	2429263

COMPACT



IMPACT

These high-performance and heavy-duty electric airless paint sprayers are designed for sustained operation on a wide variety of projects, from a single room in a house to a warehouse or manufacturing facility. The Impact Series electric airless sprayers are durable with jobsite features that keep contractors spraying.

Business is demanding and you need the kind of performance you expect from TITAN sprayers. It's time to invest in the extensive features and performance that will make a major IMPACT on your profit margin.

MAXIMIZE YOUR INVESTMENT WITH THE IMPACT SERIES.

FIELD SERVICEABLE FLUID SECTION

- ◆ 1-piece UHMWPE polyethylene packings and no cylinder to wear out.



DURALIFE BRUSHLESS HE MOTOR

- ◆ For Impact 540–1640
- ◆ Optimized for every tip size and every painter's technique.

AUTO OILER

- ◆ Standard on all 440 and larger models.
- ◆ Deliver oil to the packings with the push of a button.



QUAD+ PACKINGS / PERMALIFE CYLINDER

- ◆ No wearable cylinder
- ◆ Self-adjusting/self compensating packings
- ◆ Deliver the longest life and lowest repair costs in the industry.



IMPACT



IMPACT 400

When it comes to getting powerful performance at an affordable price, nothing comes close to the Impact 400. Perfectly suited for residential, property maintenance and small commercial applications, the Impact 400 applies all paints, stains, standard primers, lacquers and architectural coatings with ease.

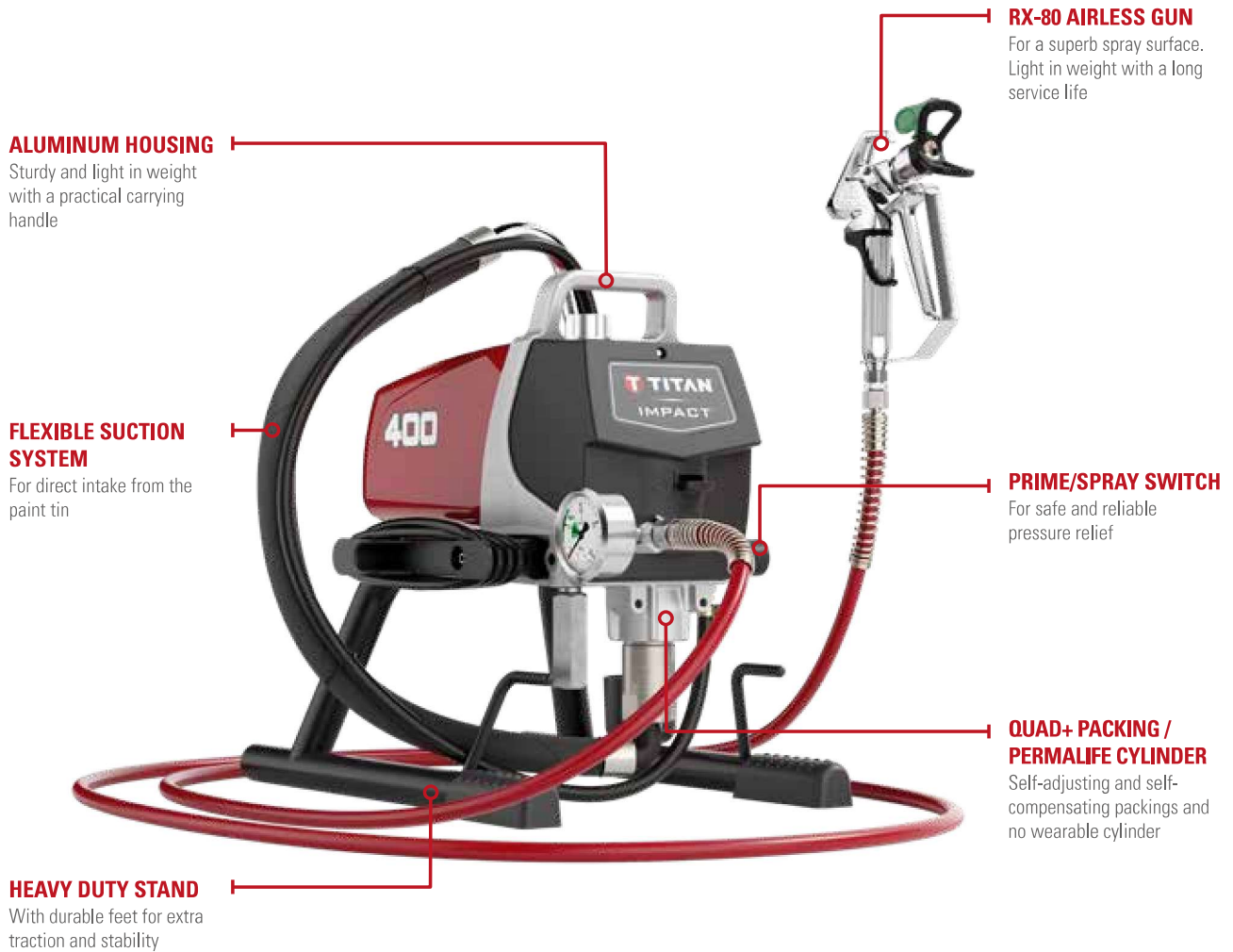

SPECIFICATIONS	IMPACT 400
Max. Delivery	2.0 l/min
Max. Tip Size	0.021"
Max. Operating Pressure	207 bar / 20.7 MPa
Max. Viscosity	20000 mPas
Weight	13.6 kg
Engine / Motor	Electric Engine 1.0 kW
Voltage	220-240 V, 50/60 Hz
Scope of delivery	Impact 400 base unit, Flexible Suction System, RX-80 Airless Gun, HEA Pro Tip 517, 15 m x 1/4" Airless hose
PART-NO.	0532034

IMPACT 440

**ONLY
WHILE
STOCKS
LAST**

Step up to the #1 selling sprayer in the industry, the Impact 440. The Impact 440 is ideally suited for residential, property maintenance and small commercial applications. This high performance electric airless sprayer will apply all standard architectural primers, paints and coatings efficiently.

ELECTRONIC PRESSURE CONTROL
With quick cleaning

T-SLOT PISTON

- Easily replacing of the entire fluid section or the packings
- 100% field serviceable

SUREFLO PUSHER VALVE
Unstick the lower ball valve with a push of a button

RX-80 AIRLESS GUN
For a superb spray surface. Light in weight with a long service life.

AUTO OILER
Deliver oil from the reservoir to the packings with the push of a button

QUAD+ PACKING / PERMALIFE CYLINDER
Self-adjusting and self-compensating packings and no wearable cylinder

IMPACT



SPECIFICATIONS	IMPACT 440
Max. Delivery	2.0 l/min
Max. Tip Size	0.023"
Max. Operating Pressure	221 bar / 22.1 MPa
Max. Viscosity	20000 mPas
Weight	18 kg
Engine / Motor	Electric Engine 1.035 kW
Voltage	220-240 V, 50/60 Hz
Scope of delivery	Impact 440 base unit, Flexible Suction System, RX 80 4-Finger Airless Gun, SC-6+ 517 Tip, 15 m x 1/4" Airless hose
PART-NO.	0532035A

ONLY
WHILE
STOCKS
LAST

IMPACT 540

The Impact 540 is a step-up performer designed for more extended use in residential, municipal, property maintenance, and small commercial applications where a greater degree of performance is required on a steady and consistent basis.

DEDICATED HOSE STORAGE

For tidy and compact transport and storage

DURLIFE BRUSHLESS HE MOTOR

Optimized for every tip size and every applicator's technique

FULL-SIZED MANIFOLD FILTER

Filter handles more paint, preventing abrasives from reaching the gun tip

ELECTRONIC PRESSURE CONTROL

With quick cleaning

RX-PRO AIRLESS GUN

For a superb spray surface. Light in weight with a long service life and an ergonomic design

AUTO OILER

Deliver oil from the reservoir to the packings with the push of a button

QUAD+ PACKINGS

Self-adjusting and self-compensating

PERMALIFE CYLINDER

Reduced wear



SPECIFICATIONS

IMPACT 540

Max. Delivery	2.3 l/min
Max. Tip Size	0.024"
Max. Operating Pressure	221 bar / 22.1 MPa
Max. Viscosity	20000 mPas
Weight	27.4 kg
Engine / Motor	Electric Engine 1.035 kW
Voltage	220-240 V, 50/60 Hz
Scope of delivery	Impact 540 base unit, RX-Pro Airless Gun, SC-6+ 517 Tip, 15 m x 1/4" Airless hose

PART-NO.

0532031

IMPACT 740

The Impact 740 is designed for extended, heavy-duty performance on larger residential and commercial projects. This is the sprayer contractors turn to when the time comes to enter the big leagues.



IMPACT



SPECIFICATIONS	IMPACT 740
Max. Delivery	3.0 l/min
Max. Tip Size	0.029"
Max. Operating Pressure	221 bar / 22.1 MPa
Max. Viscosity	25000 mPas
Weight	44 kg
Engine / Motor	Electric Engine 1.725 kW
Voltage	220-240 V, 50/60 Hz
Scope of delivery	Impact 740 base unit, RX-Pro Airless Gun, SC-6+ 517 Tip, 15 m x 1/4" Airless hose
PART-NO.	0532032

IMPACT 1040

For big projects requiring large tip sizes or more than one spray gun operating from a single unit, you can rely on the power and performance of the Impact 1040. This workhorse is perfect for large residential, commercial and industrial applications where

speed and power are necessary to get the job done faster and with greater efficiency.



SPECIFICATIONS	IMPACT 1040
Max. Delivery	4.5 l/min
Max. Tip Size	0.034"
Max. Operating Pressure	221 bar / 22.1 MPa
Max. Viscosity	25000 mPas
Weight	48 kg
Engine / Motor	Electric Engine 1.955 kW
Voltage	220-240 V, 50/60 Hz
Scope of delivery	Impact 1040 base unit, RX-Pro Airless Gun, SC-6+ 517 Tip, 15 m x 1/4" Airless hose
PART-NO.	0532033

IMPACT 1640

The Impact 1640 is driven by 240 volt electric motor delivering the power to spray heavy bodied abrasive coatings and smooth texture applications with ease.



IMPACT



SPECIFICATIONS	IMPACT 1640
Max. Delivery	5.0 l/min
Max. Tip Size	0.039"
Max. Operating Pressure	221 bar / 22.1 MPa
Max. Viscosity	30000 mPas
Weight	50 kg
Engine / Motor	Electric Engine 2.185 kW
Voltage	220-240 V, 50/60 Hz
Scope of delivery	Impact 1640 base unit, S-3 Airless Gun, SC-6+ 523 Tip, 15 m x 3/8" Airless hose, 2 m x 1/4" Whip
PART-NO.	2413451



IMPACT X

Multiply your productivity Xponentially with the Xtended line of Impact sprayers, now with more variety and more options. They're the Impact sprayers you know and love re-engineered and re-imagined for the future. The electric airless sprayers in the Impact X series are as durable as their predecessors, but have additional smart product benefits that make working on the construction site even easier for the user.

Thanks to the Bluetooth-enabled connection, the devices are ideal for use in combination with the MyTITAN app, but users can also benefit from many advantages without the app. Spray faster, smarter, and better every time.

THE ULTIMATE COMBINATION OF POWER & PERFORMANCE

DURALIFE HE BRUSHLESS MOTOR

- ◆ The DuraLife HE Brushless Motor makes the Impact X Series the most powerful ever
- ◆ Durable, reliable, and long-lasting, it runs cooler for years of maintenance-free operation
- ◆ Backed by our WearGuard Lifetime Motor Warranty



LOGIX ADAPTIVE PRESSURE CONTROL SYSTEM

- ◆ Enhances performance through all-new tip-sensing technology that adjusts power and pump speed delivering smooth and steady flow with consistent pressure
- ◆ Optimized to provide maximum power when using larger tips or big jobs and maximum control when using smaller tips or fine finish applications
- ◆ Protect your investment with a pump that works only as hard as it needs to



SMART DESIGN - ALL NEW FEATURES

- ◆ Vertical Filter Housing completely drains coatings and cleans up to 3X faster with as little as 1/3 of the water (Impact X 540I models)
- ◆ 360° adjustable ergonomic handle provides maximum comfort, grip, and portability
- ◆ Eliminate splashback with the improved lever action Prime/Spray Valve ensures gradual and even pressure release
- ◆ Compact design is lighter than competitive models for increased portability and reduced storage footprint



IMPACT X



IMPACT X 540I

Take your work to the next level with the Impact X 540I. This powerful sprayer from the Impact X Series delivers outstanding performance and, with TITAN's exclusive IntelliSync Technology, seamlessly integrates with the MyTITAN system for efficient control of your spraying operations.

The unit is ideal for applying stains, lacquers, enamels, emulsion, and other low to medium viscosity coatings. The durable and smart design makes it easy to use, even for airless beginners.

VERTICAL FILTER HOUSING

Cleans up to 3X faster using as a 1/3 of the water

LEVER ACTION BYPASS VALVE

Eliminate splashback with gradual pressure release

MAXFX NO TOOLS FLUID SECTION

Quick-change with just your hands to replace in minutes on the job

360° ADJUSTABLE HANDLE

Maximum comfort, grip and portability.

DURALIFE HE BRUSHLESS MOTOR

Makes the X 540I the most powerful 540 ever

LOGIX ADAPTIVE PRESSURE CONTROL SYSTEM

Tip-sensing technology that adjusts power and pump speed delivering smooth and steady flow with consistent pressure

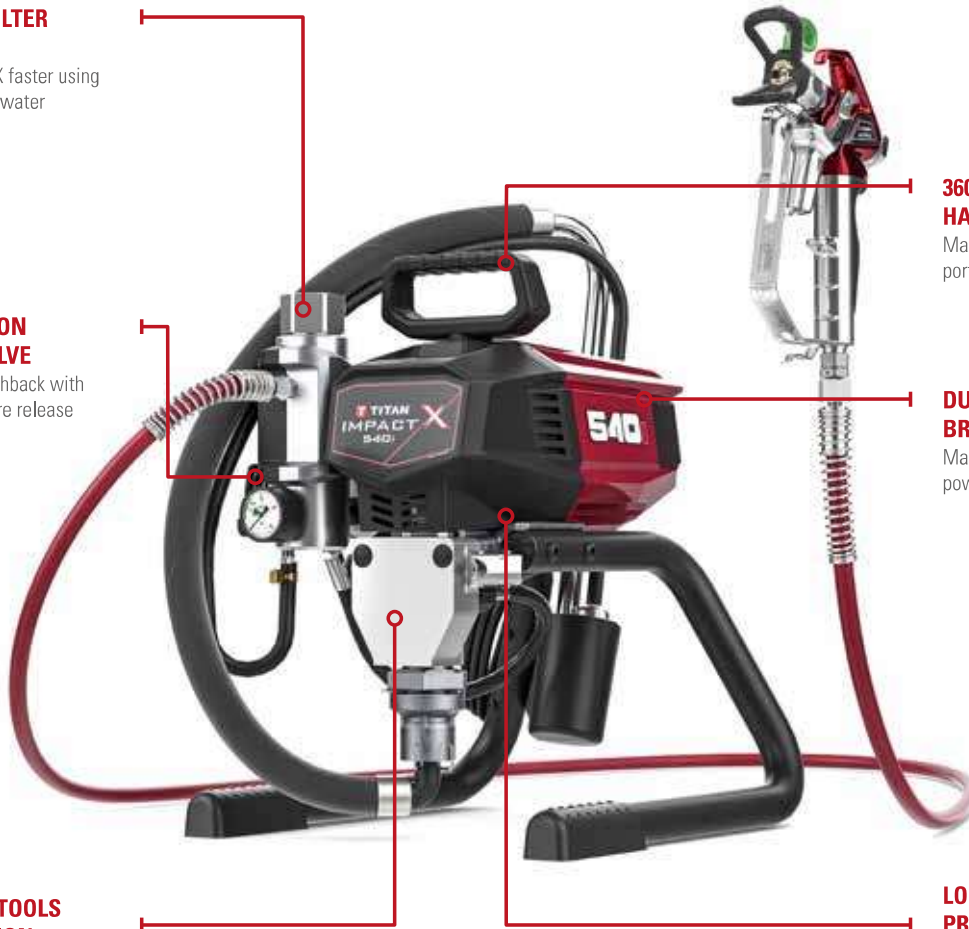

SPECIFICATIONS	IMPACT X 540I
Max. Delivery	2.2 l/min
Max. Tip Size	0.023"
Max. Operating Pressure	228 bar / 22.8 MPa
Max. Viscosity	20000 mPas
Weight	13.6 kg
Engine / Motor	Electric Engine 1.05 kW
Voltage	220-240 V, 50/60 Hz
Scope of delivery	Impact X540I base unit, RX-80 Airless Gun, HEA Pro 517 Tip, 15 m x 1/4" Airless hose
PART-NO.	2428909

INTRODUCING TITAN'S CONNECT SPRAYERS

CONNECT. CONTROL. MANAGE

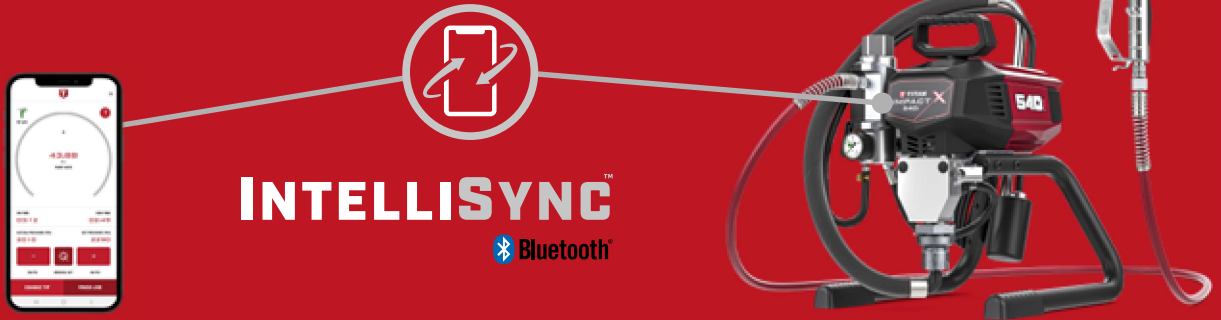

These fully featured sprayers offer the ultimate in functionality and convenience for the longest days and biggest projects. Capable of supporting large tip sizes and multiple guns, you can rely on the power and performance of the Impact Connected Sprayers. Now available with IntelliSync Technology powered by Bluetooth to connect to the MyTITAN app for ultimate control.

IMPACT X

THE MYTITAN APP GIVES CONTRACTORS ULTIMATE CONTROL

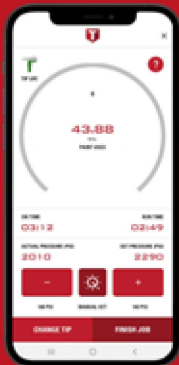

Real-Time Dashboard

Monitor and adjust pressure, run time, paint usage, and tip life.



Tip Wear Indicator

Track your spray tip status in real time, with the industry's first and only tip wear indicator.



Start-Up Assistant

Get ideal pressure settings, tip size, and filter recommendations customized for every situation.



POWRBEAST

Since their introduction, direct immersion hydraulic piston sprayers have been the choice for serious contractors for large scale residential, commercial and industrial applications.

Whoever said power and intelligence can't go together? PowrBeast is the ultimate combination of strength and intelligence, making you look smarter on every job. Here's what makes PowrBeast the ultimate package.

OUR PRODUCT HIGHLIGHTS

FEATURING SEVERE SERVICE FLUID SECTION

- ◆ Long and slow stroking piston maximizes power and durability
- ◆ Proven TITAN technology with 35 years in the field
- ◆ Field serviceable with easy to remove/replace fluid section

FEATURING HYDRASTROKE TECHNOLOGY

- ◆ Unmatched durability and performance powered by digitally driven hydraulics
- ◆ Versatility to spray heavy and light bodied coatings without worry of burning out clutches
- ◆ System is optimized with one moving part reducing heat and extending life

FEATURING INTELLIGENT DESIGN

- ◆ Extremely efficient cooling system
- ◆ Fan and shroud maximize cool air flow over warm areas
- ◆ Radiator-style active cooling hydraulic tank
- ◆ Large 12" pneumatic tyres and telescoping handle make it easy to move around the job site
- ◆ Simplified pump assembly for easier service



FLUID SECTION



HYDRASTROKE TECHNOLOGY



INTELLIGENT DESIGN

POWRBEAST



POWRBEAST 7700

The PowrBeast 7700 delivers extreme durability and the power to spray heavy bodied finish coatings on large residential or commercial jobs with ease. Take a step up in power delivering Up to 7.6 litres per minute means you can connect up to 4 guns and keep a larger crew spraying.

TELESCOPING HANDLE WITH HOSE WRAP

BUILT-IN LIFT HANDLES

For easy loading and unloading

RADIATOR STYLE HYDRAULIC RESERVOIR

Maximizes airflow to actively cool the system

COOLING SHROUD

Directs air movement across the hydraulic oil tank keeping it cooler

LARGE 12" PNEUMATIC TYRES

For increased portability and travel over rough surfaces

HYDRASTROKE TECHNOLOGY

Efficient and versatile with no clutch to burn

AIRLESS GUN, HOSE & TIP KIT

Comes standard with every PowrBeast 7700

20 LITRE BUCKET HOLDER

EASILY ACCESSIBLE FLUID SECTION AND HYDRAULIC PISTON

For easy maintenance and service

SEVERE SERVICE FLUID SECTION

Powerful slow stroking piston

SUBMERSED FOOT VALVE

Maximizes suction for heavy graded materials

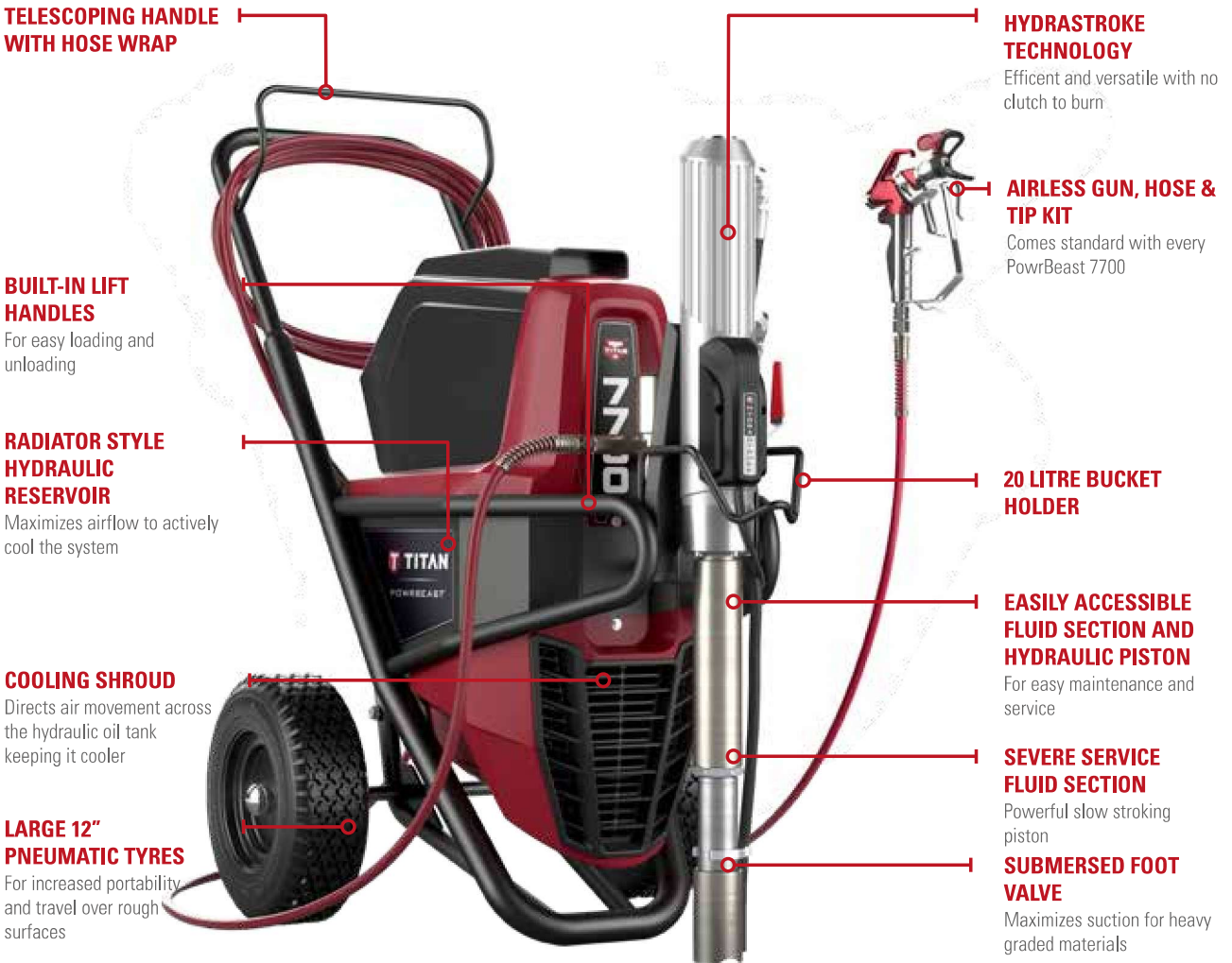

SPECIFICATIONS

POWRBEAST 7700 ELECTRIC

Max. Delivery	6 l/min
Max. Tip Size (1 Gun)	0.043"
Max. Tip Size (2 Guns)	0.031"
Max. Tip Size (3 Guns)	0.023"
Max. Tip Size (4 Guns)	0.021"
Max. Operating Pressure	248 bar / 24.8 MPa
Max. Viscosity	50000 mPas
Weight	85 kg
Engine / Motor	Electric Engine brushless 3.1 kW
Voltage	~ 230V, 50/60 Hz
Scope of delivery	PowrBeast 7700 Electric base unit, S-3 Gun, TR' 517 Tip, 15 m x 3/8" Airless Hose, 2 m x 1/4" Whip

PART-NO.

0537003



POWERBEAST



POWRTWIN

Since their introduction almost half a century ago, TITAN PowrTwin hydraulic piston sprayers have a well-earned reputation for durability and dependability among serious contractors for large scale residential, commercial and industrial applications and multi-gun usage.

The PowrTwin Series is the perfect match for any serious coating contractor who needs to switch from electric to petrol power and back again all on a moment's notice.

OUR PRODUCT HIGHLIGHTS

LONG-LASTING POWER - FEATURING SEVERE SERVICE FLUID SECTION

- ◆ Cylinder and piston rod are tempered with a proprietary heat-treating process that extends pump life by 150 % over competing pumps
- ◆ Self-adjusting packings resist over-tightening and help prevent premature wear
- ◆ Powerful, slow-stroking piston

WHERE MUSCLE MEETS RELIABILITY - FEATURING SPEEFLO HYDRADRIVE TECHNOLOGY

- ◆ Smooth, slow-stroking hydraulic drive provides extreme power and reliability
- ◆ Reliable mechanical valve delivers efficient performance
- ◆ External hydraulic fluid porting allows for quick and easy field service

POWER WHERE YOU NEED IT - FEATURING FULL CONVERTIBILITY

- ◆ Tool-free convertibility from electric to petrol power and vice versa
- ◆ Precise pressure control to spray everything from low-viscosity primers to heavy-bodied coatings
- ◆ Durable cart with telescoping handle and lift handles for optimal job-site mobility



FLUID SECTION



HYDRADRIVE TECHNOLOGY



FEATURING FULL CONVERTIBILITY



POWRTWIN

POWRTWIN 4900 PLUS

Designed and built for contractors who are serious about completing large scale painting projects quickly and profitably. The PowrTwin 4900 Plus is ideal for professionals who want the slow-stroking power and maximum durability that only the

PowrTwin 4900 Plus can deliver. Delivering up to 5.7 litres per minute means you can connect up to 3 guns and keep a crew spraying.

HEAVY-DUTY FRAME

Durable cart with telescoping handle and convenient lift handles

SEVERE SERVICE 900 PUMP

Cylinder and piston rod are tempered with a proprietary heat-treating process that increases pump life by 150 % over competitive pumps. Self-adjusting packings prevent overtightening and premature wear

RX-PRO GUN, HOSE & TIP KIT

Comes standard with every PowrTwin 4900 PLUS pump

SPEEFLO HYDRADRIVE

Smooth, slow-stroking hydraulic drive provides extreme power and reliability

CONVERTIBLE

Easy, tool-free convertibility for projects where petrol engines are not permitted. (Convertokit for conversion to electrical operation sold separately Part.No.0290321A - 230 V)

HIGH EFFICIENCY COOLING FAN

Keeps the hydraulics cooler for longer life

◀ ELECTRIC VERSION

▼ PETROL POWERED VERSION

BELT GUARD

Pivotable housing provides easy access for belt replacement and power source conversion



SPECIFICATIONS	POWRTWIN 4900 PLUS PETROL	POWRTWIN 4900 PLUS ELECTRIC
Max. Delivery	6.9 l/min	5.7 l/min
Max. Tip Size (1 Gun)	0.044"	0.038"
Max. Tip Size (2 Guns)	0.031"	0.027"
Max. Tip Size (3 Guns)	0.025"	0.021"
Max. Operating Pressure	228 bar / 22.8 MPa	228 bar / 22.8 MPa
Max. Viscosity	50000 mPas	50000 mPas
Weight	60 kg	63 kg
Engine / Motor	Honda GX160	Electric Engine 2.6 kW
Voltage	-	230 V~, 50 Hz
Scope of delivery	PowrTwin 4900 PLUS petrol powered base unit, RX-Pro Gun & TR1 517 Tip, 15 m x 1/4" Airless Hose	PowrTwin 4900 PLUS Electric base unit, RX-Pro Gun & TR1 517 Tip, 15 m x 1/4" Airless Hose
PART-NO.	290012	290032

POWRTWIN 6900 PLUS

Designed and built for contractors who are serious about completing large scale painting projects quickly and profitably. The PowrTwin 6900 Plus is ideal for professionals who want the slow-stroking power and maximum durability that only the PowrTwin 6900 Plus can deliver.

HEAVY-DUTY FRAME

Durable cart with telescoping handle and convenient lift handles

SEVERE SERVICE 900 PUMP

Cylinder and piston rod are tempered with a proprietary heat-treating process that increases pump life by 150 % over competitive pumps.

S-3 GUN, HOSE & TIP KIT

Paint carrying parts made of high quality stainless steel

SPEEFLO HYDRADRIVE

Smooth, slow-stroking hydraulic drive provides extreme power and reliability.

Powered by HONDA GX160 ENGINE

Dependable, petrol-powered engine with low-oil alert

HIGH EFFICIENCY COOLING FAN

Keeps the hydraulics cooler for longer life

CONVERTIBLE

Easy, tool-free convertibility for projects where petrol engines are not permitted.

BELT GUARD

Pivotable housing provides easy access for belt replacement and power source conversion



Optional Convertokit for conversion to electrical operation sold separately P/N 0290321A - 230 V

SPECIFICATIONS	POWRTWIN 6900 PLUS PETROL
Max. Delivery	8.52 l/min
Max. Tip Size (1 Gun)	0.050"
Max. Tip Size (2 Guns)	0.035"
Max. Tip Size (3 Guns)	0.029"
Max. Tip Size (4 Guns)	0.025"
Max. Operating Pressure	228 bar / 22.8 MPa
Max. Viscosity	50000 mPas
Weight	63 kg
Engine / Motor	Honda GX160
Scope of delivery	PowrTwin 6900 PLUS petrol powered base unit, S-3 Gun & TR ¹ 517 Tip, 15 m x 1/4" Airless Hose

PART-NO. 290013

POWRTWIN

POWRTWIN 6900 PLUS DI

The PowrTwin 6900 PLUS DI is made for very large scale projects where up to 4 guns may be needed, or application of very heavy coatings. The EZ swing frame decreases spillage during paint

changes and lower height (and center of gravity) of unit for easy transportation and easy handling.

RX-APEX NON-FILTER GUN & TIP KIT

Premium spray gun built for high volume commercial and industrial work

CONVERTIBLE

Easy, tool-free convertibility for projects where petrol engines are not permitted

HEAVY-DUTY FRAME

Durable cart with telescoping handle and convenient lift handles

BELT GUARD

Pivotable housing provides easy access for belt replacement and power source conversion

PETROL POWERED VERSION

ELECTRIC VERSION

SPEEFLO HYDRADRIVE

Smooth, slow-stroking hydraulic drive provides extreme power and reliability

HIGH EFFICIENCY COOLING FAN

Keeps the hydraulics cooler for longer life

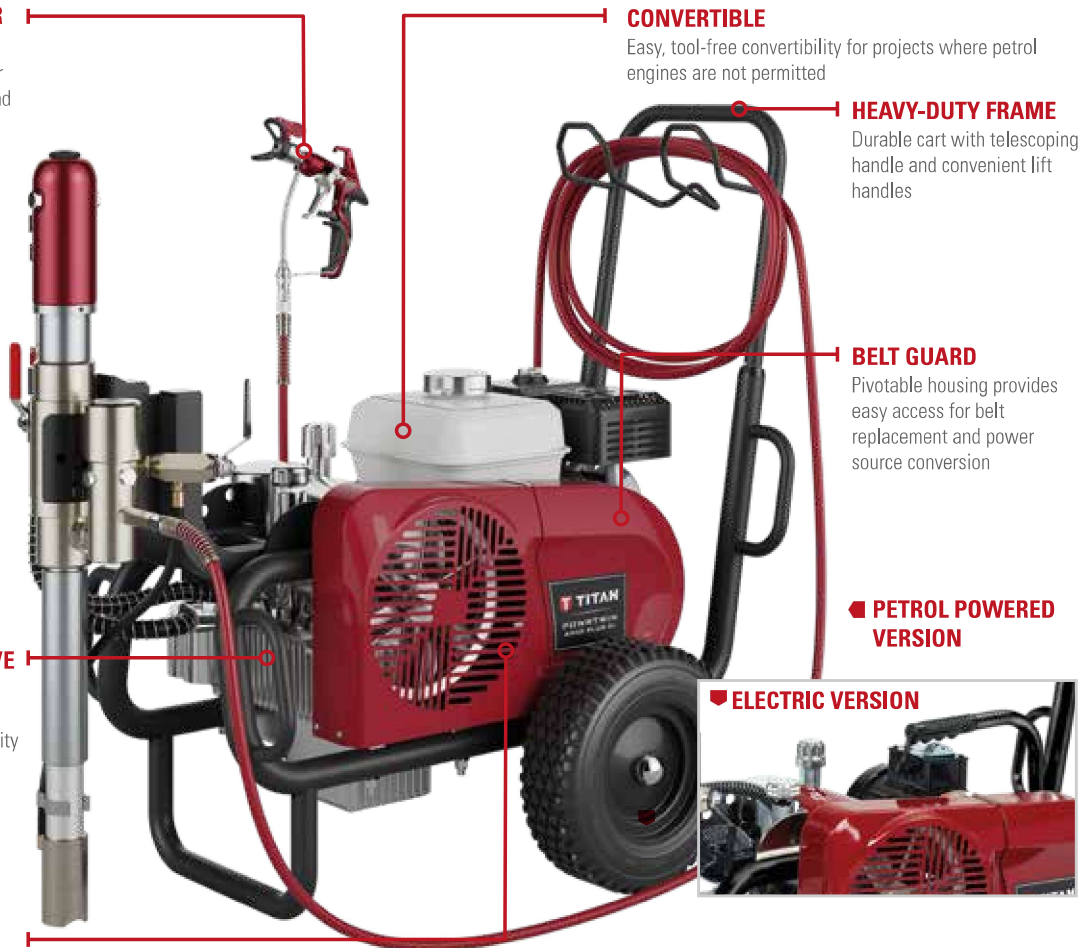

SPECIFICATIONS	POWRTWIN 6900 PLUS DI ELECTRIC	POWRTWIN 6900 PLUS DI PETROL
Max. Delivery	6.6 l/min	8.5 l/min
Max. Tip Size (1 Gun)	0.041"	0.050"
Max. Tip Size (2 Guns)	0.029"	0.035"
Max. Tip Size (3 Guns)	0.021"	0.029"
Max. Tip Size (4 Guns)	0.017"	0.025"
Max. Operating Pressure	228 bar / 22.8 MPa	228 bar / 22.8 MPa
Max. Viscosity	50000 mPas	50000 mPas
Weight	93 kg	86 kg
Engine / Motor	Electric Engine 3.1kW	Honda GX160
Voltage	230 V~, 50 Hz	-
Scope of delivery	PowrTwin 6900 PLUS DI Electric base unit, RX-Apex Non-Filter Gun & TR' 517 Tip, 15m x 3/8" Airless Hose	PowrTwin 6900 PLUS DI petrol powered base unit, RX-Apex Non-Filter Gun & TR' 517 Tip, 15m x 3/8" Airless Hose
PART-NO.	290033	290021

POWRTWIN 12000 PLUS DI

The PowrTwin DI units with submersed foot valve create the most efficient siphon system on the market today allowing the spraying of very heavy coatings. Additionally, our EZ swing frame makes this the most efficient and convenient to use petrol hydraulic system in the market today. PowrTwin 12000 Plus DI is

the flagship of the line and is recommended for very large scale projects where up to 6 guns may be needed, or application of very heavy coatings.

RX-APEX NON-FILTER GUN & TIP KIT

Premium spray gun built for high volume commercial and industrial work

CONVERTIBLE

Easy, tool-free convertibility for projects where petrol engines are not permitted.

HEAVY-DUTY FRAME

Durable cart with telescoping handle and convenient lift handles

BELT GUARD

Pivotable housing provides easy access for belt replacement and power source conversion

SPEEFLO HYDRADRIVE

Smooth, slow-stroking hydraulic drive provides extreme power and reliability

HIGH EFFICIENCY COOLING FAN

Keeps the hydraulics cooler for longer life



POWRTWIN

SPECIFICATIONS	POWRTWIN 12000 PLUS DI ELECTRIC	POWRTWIN 12000 PLUS DI PETROL
Max. Delivery	11.9 l/min	11.9 l/min
Max. Tip Size (1 Gun)	0.058"	0.058"
Max. Tip Size (2 Guns)	0.040"	0.040"
Max. Tip Size (3 Guns)	0.034"	0.034"
Max. Tip Size (4 Guns)	0.030"	0.030"
Max. Tip Size (5 Guns)	0.026"	0.026"
Max. Tip Size (6 Guns)	0.024"	0.024"
Max. Operating Pressure	248 bar / 24.8 MPa	248 bar / 24.8 MPa
Max. Viscosity	65000 mPas	65000 mPas
Weight	100 kg	88 kg
Engine / Motor	Electric Engine 5.5kW	Honda GX270
Voltage	400 V~, 50 Hz, V3~	-

Scope of delivery PowrTwin 12000 PLUS DI electric base unit, RX-Apex Non-Filter Gun & TR¹ 517 Tip, 15 m x 3/8" Airless Hose

PowrTwin 12000 PLUS DI petrol powered base unit, RX-Apex Non-Filter Gun & TR¹ 517 Tip, 15 m x 3/8" Airless Hose

PART-NO.

290034

290023



HYDRA X

With a Direct Immersion System that means no transfer pumps, flexible siphon tubes, or air compressors needed, the Hydra X Series from TITAN maximizes your efficiency on the jobsite. Featuring limit-sensing hydraulics for better control and interchangeable fluid sections, an AutoLift system raises and lowers the fluid section with the push of a button.

Built for maximum durability and power the TITAN Hydra X Series delivers when the job calls for the toughest coatings. Check out what makes these the industry's best roofing and protective coating sprayers.



OUR PRODUCT HIGHLIGHTS

HYDRASTROKE TECHNOLOGY

- ◆ Unmatched durability and performance powered by electronically controlled hydraulics
- ◆ Hydra X has the versatility to spray heavy and light bodied coatings with ease
- ◆ Hydraulic motor is optimized with one moving part, reducing heat and extending life

SEVERE SERVICE FLUID SECTION

- ◆ 13 cm long, slow stroking piston maximizes power and efficiency to extend the pump life
- ◆ Uses a Tri-chrome process to create the industry's most durable fluid section with packings designed specifically for aggressive coatings
- ◆ Proven TITAN self-adjusting packing technology with over 45 years in the field extends time between repacks
- ◆ New patent pending quick removal fluid section allows one person to service on the jobsite with ease

SMART DESIGN

- ◆ Effortless drum changes with the electric AutoLift system that raises and lowers the fluid section with the touch of a button
- ◆ One sprayer with modular fluid sections allowing for two different performances out of one sprayer
- ◆ Large 12" pneumatic tyres make it easy to move around job site

EXTREMELY EFFICIENT COOLING SYSTEM

- ◆ Two cooling fans to maximize air flow over hydraulic system
- ◆ Large 23 Litre hydraulic fluid reservoir

HYDRASTROKE TECHNOLOGY

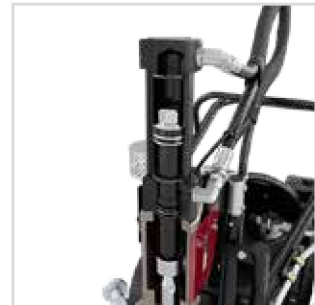

SEVERE SERVICE FLUID SECTION

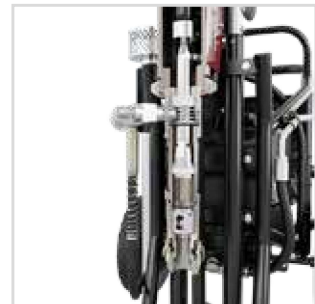

SMART DESIGN



EXTREMELY EFFICIENT COOLING SYSTEM

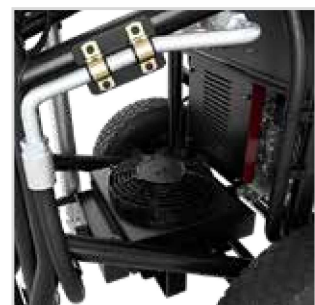

HYDRA X

ONE SPRAYER MANY MATERIALS

Hydra X sprayers have a high-capacity power to manhandle the toughest architectural and aggressive protective coatings.

COMMON COATINGS	HYDRA X 4540	HYDRA X 7230
Latex	X	X
Primers	X	X
Block Filler	X	-
Enamel	X	X
Elastomerics	X	X
Acrylics	X	X
Epoxy	-	X
Polyester	X	X
Polyurethane	X	X
Fibered Asphalt Emulsion	X	X
Coal Tar	X	X
Mastics	X	X
Water Proofing	X	X
Contact Cement	X	X
Joint Compound	X	-
Aluminum Emulsion	X	X
Acrylic Elastomeric	X	X
Emulsion Primer	X	X
Silicone	-	X
Intumescent	-	X

A WORKHORSE FOR ANY JOBSITE

- Roofing
- Bridges
- Railroad
- Cargo Containers
- Commercial Construction
- Residential Construction
- Secondary Containment
- Below Grade Waterproofing

WHY HYDRA?

- Industry Leading Performance
- Eliminates the Need for Transfer Pump
- Meets Needs of Multiple Market Segments
- Versatile Application
- Field Serviceable Quick-Change Fluid Section
- Efficient Hydraulics
- Minimal Down Time

DID YOU KNOW...

By purchasing a fluid section conversion kit you can switch performance from one pressure and l/min to the other by simply changing the fluid section. Yes. Two machines in one!

Hydra X 4540 to 7230 Conversion Kit
p/n 2424618

Hydra X 7230 to 4540 Conversion Kit
p/n 2432905A

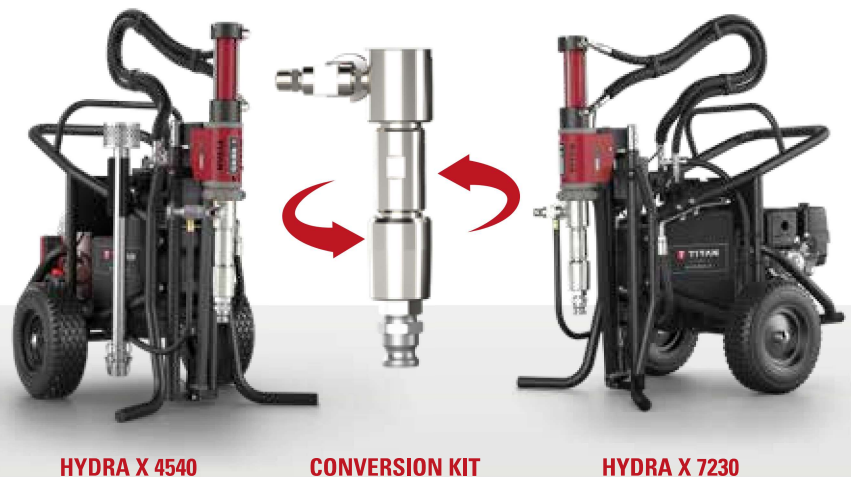



HYDRA X

HYDRA X 4540

The new Hydra X 4540 roofing and protective coatings sprayer combines the power and pressure needed to spray the toughest coatings. Built to last with HydraStroke Technology and Severe Service fluid section which maximize durability. Additional, new key features like the new AutoLift system and quick change fluid sections make jobsite life easier and more productive. Hydra X

4540 is excellent for high solids elastomeric and high production. Ideal for spraying primarily acrylic elastomeric roof coatings, asphalt emulsions, zinc coatings or commercial architectural coatings.

LARGE HOSE WRAP
Holds up to 60 m of DN13

Powered by
HONDA
GX390 ENGINE

- Fuel efficient with all the power and performance of a Honda
- Low oil alert system prevents engine seizure
- Electric start

12" PNEUMATIC TYRES AND BALANCED CART
For easy maneuverability

AUTOLIFT SYSTEM

Raises the fluid section to easily change out drums or buckets

HYDRASTROKE TECHNOLOGY

- Cool running, durable hydraulics
- Stroke detection senses top and bottom for precision control limits
- Regenerative circuit keeps pressures balanced from upstroke to downstroke

FIELD-SERVICEABLE FLUID SECTION

The fluid section can be easily swapped out on the jobsite minimizing downtime

AUTOMOTIVE STYLE RADIATOR

Optimized to keep system cool

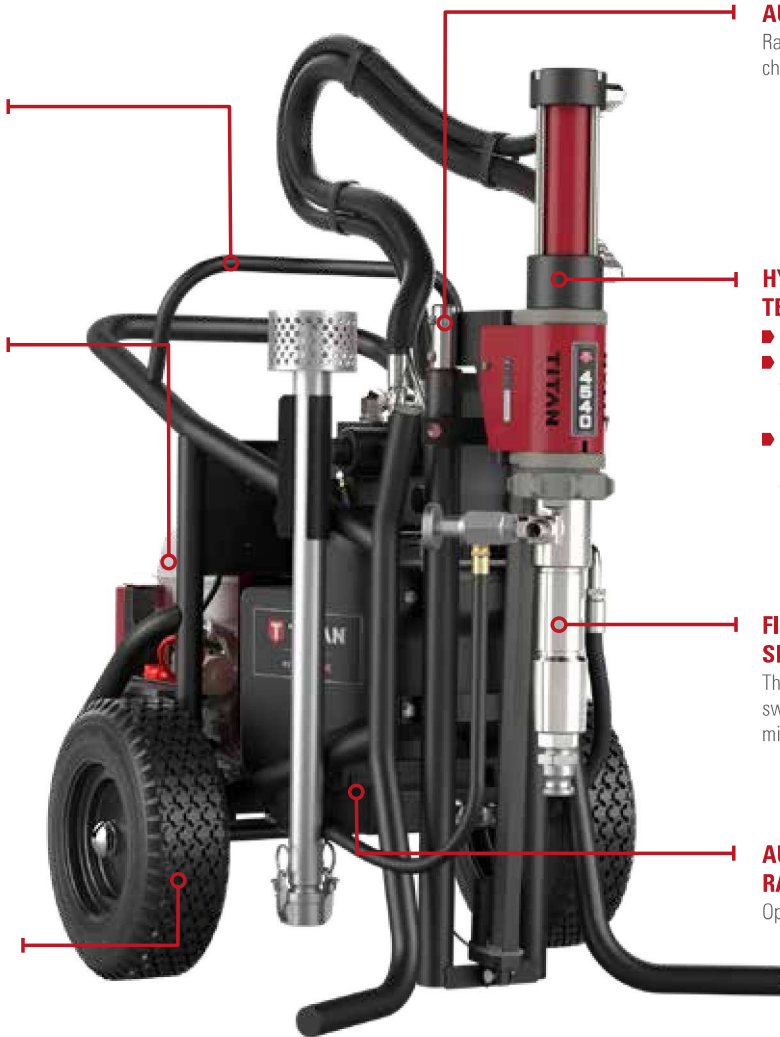

SPECIFICATIONS	HYDRA X 4540
Max. Delivery - Petrol	15.1 l/min
Max. Tip Size - 1-Gun	0.067"
Max. Tip Size - 2-Guns	0.041"
Max. Tip Size - 3-Guns	0.035"
Max. Tip Size - 4-Guns	0.031"
Max. Tip Size - 5-Guns	0.029"
Max. Tip Size - 6-Guns	0.025"
Max. Operating Pressure	310 bar / 31 MPa
Max. Viscosity	65000 mPas
Weight	177 kg
Engine / Motor	Honda GX390
Scope of delivery	Hydra X 4540 base unit, Rigid Suction Set for barrel (Hose, Gun & Tips not included)
PART-NO.	2412275

HYDRA X 7230

The new Hydra X 7230 roofing and protective coatings sprayer is built to last and make jobsite life easier and more productive. This is the workhorse you want to have in your fleet when it comes to the toughest coatings. It combines the power and pressure needed to handle these materials. The new key features like the new AutoLift system and quick change fluid

sections maximises the performance with minimum downtime. Never been so easy to change out barrel or bucket. Built to last with HydraStroke Technology and Severe Service fluid section which maximizes durability. Hydra X 7230 is a powerful high pressure sprayer for hard to atomize materials like silicones, epoxies and elastomers.



HYDRASTROKE TECHNOLOGY

- Cool running, durable hydraulics
- Stroke detection senses top and bottom for precision control limits
- Regenerative circuit keeps pressures balanced from upstroke to downstroke

FIELD-SERVICEABLE FLUID SECTION

The fluid section can be easily swapped out on the jobsite minimizing downtime

AUTOMOTIVE STYLE RADIATOR

Optimized to keep system cool

AUTOLIFT SYSTEM

Raises the fluid section to easily change out drums or buckets

LARGE HOSE STORAGE

Holds up to 60 m of DN13

Powered by **HONDA GX390 ENGINE**

- Fuel efficient with all the power and performance of a Honda
- Low oil alert system prevents engine seizure
- Electric start

12" PNEUMATIC TYRES AND BALANCED CART

For easy maneuverability



SPECIFICATIONS	HYDRA X 7230
Max. Delivery - Petrol	10.6 l/min
Max. Tip Size - 1-Gun	0.065"
Max. Tip Size - 2-Guns	0.035"
Max. Tip Size - 3-Guns	0.028"
Max. Tip Size - 4-Guns	0.025"
Max. Tip Size - 5-Guns	0.021"
Max. Tip Size - 6-Guns	-
Max. Operating Pressure	500 bar / 50 MPa
Max. Viscosity	65000 mPas
Weight	177 kg
Engine / Motor	Honda GX390
Scope of delivery	Hydra X 7230 base unit, Rigid Suction Set for barrel (Hose, Gun & Tips not included)
PART-NO.	2412277

HYDRA X



POWRLINER

Whether you're an entry-level contractor or a seasoned industry pro, the PowrLiner series is designed for quick and professional work on any surface.

Choose from clutch-driven, sealed hydraulic, or hydraulic-powered striper with five models ranging from 2.8 to 9.5 litres. Perfect for small jobs and everyday use.

OUR PRODUCT HIGHLIGHTS

- TITAN builds high quality line striping equipment. Assembled in the US, equipped with high precision durable parts
- Our products are tested to withstand your job conditions each and every day
- Innovative features ensure maximum performance with minimized downtime
- All field & pavement sprayers are proven to turn even the biggest, toughest jobs into routine results
- We aim to deliver an unmatched level of precision and consistency for your lines

RELIABLE PETROL ENGINE

- High performance: proven engine technology with high fuel efficiency and power output
- Lower vibration, less noise
- Simple and easy operation guarantee ease of use
- High quality components ensure component reliability



POWRCENTER

Designed with convenient and easy to use controls with features like tip holder, 12 V-phone charging port and cup holder. (Phone, charger and cup not included.)

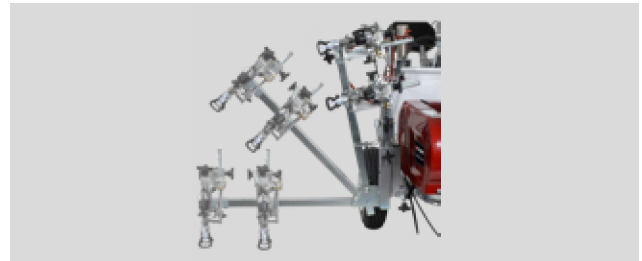

SMARTARM

Built to pivot and lift, making line adjustments and transportation quick and easy.

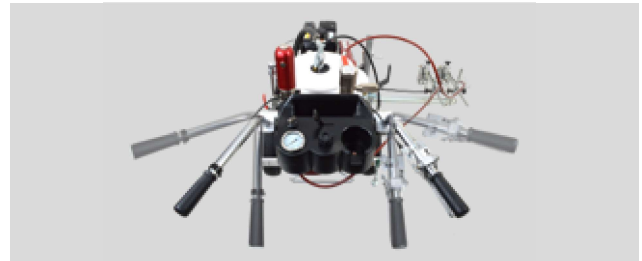

DEADLOCK HANDLEBARS

Easily adjust handlebars on three planes; in and out, up and down and pivot forward or back.



POWRLINER SERIES - THE SPRAYERS OF CHOICE

These high-performance, heavy-duty paint sprayers use sealed hydraulic diaphragm or slow-cycling hydraulic piston technology for economical operation and dependable, long-term line

spraying. The sprayers of choice for serious contractors with large-scale contractors projects.

DIAPHRAGM PUMP

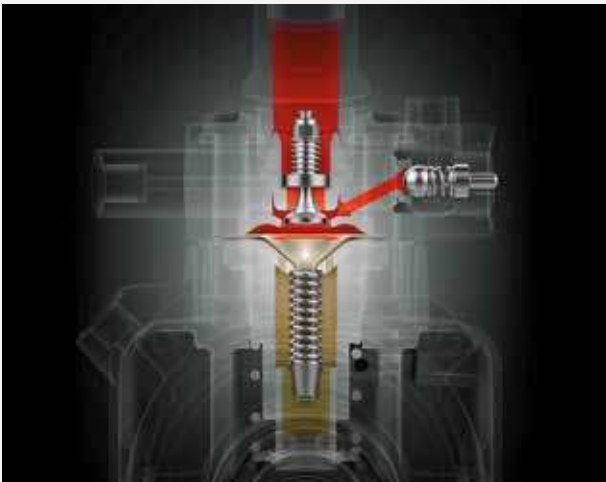

PISTON PUMP



PERMASTROKE TECHNOLOGY

- Delivers consistent lines whilst eliminating deadband
- Easy priming guaranteed every time through the Sureflo Pusher valve
- Provides ideal fan patterns at pressures from 20 to 228 bar, including small and large spray tip sizes
- Ultra smooth operation and minimized pulsation guaranteed with FlatLine Pulsation Dampener

UNMATCHED DURABILITY AND RELIABILITY

- Offers peace of mind with PermaStroke Technology, no pistons, packings, or cylinders to wear out and no clutch to replace
- Field serviceable, quickly change out the cartridge-style inlet and outlet valves in less than 5 minutes, using regular tools
- Reduced maintenance cost and minimized downtime thanks to quick & easy service

SPEEFLO HYDRADRIVE

- Reliable, smooth, slow-stroking hydraulic drive greatly extends the operational life of the sprayer
- External-hydraulic fluid porting with upgraded fittings allows for quick troubleshooting and simplified maintenance
- SAE o-ring fitting and precision rod alignment ensure maximum pump life

SEVERE SERVICE 900 PUMP

- Cylinder and piston rod are tempered with a proprietary heat-treating process that increases pump life up to 150 % longer than competitive pumps
- Self-adjusting packings prevent over-tightening and help prevent premature wear
- Foot valve removes easily for faster cleaning and easy maintenance
- Reversible inlet and outlet seats have twice the lifespan of ordinary outlet seats and extra large ball valves ensure efficient pump operation and longer unit life
- Heavy-duty prime/spray valve ensures consistent, increased flow and faster pump priming

POWRLINER 3500

The PowrLiner 3500 was developed specifically for continuous daily use on asphalt, sports line marking and grassed areas delivering a spray pattern just like a hydraulic pump. It's the

perfect line marking machine for companies looking for a mid range sprayer. It's more suited to jobs where a hydraulic pump wouldn't be considered economical.

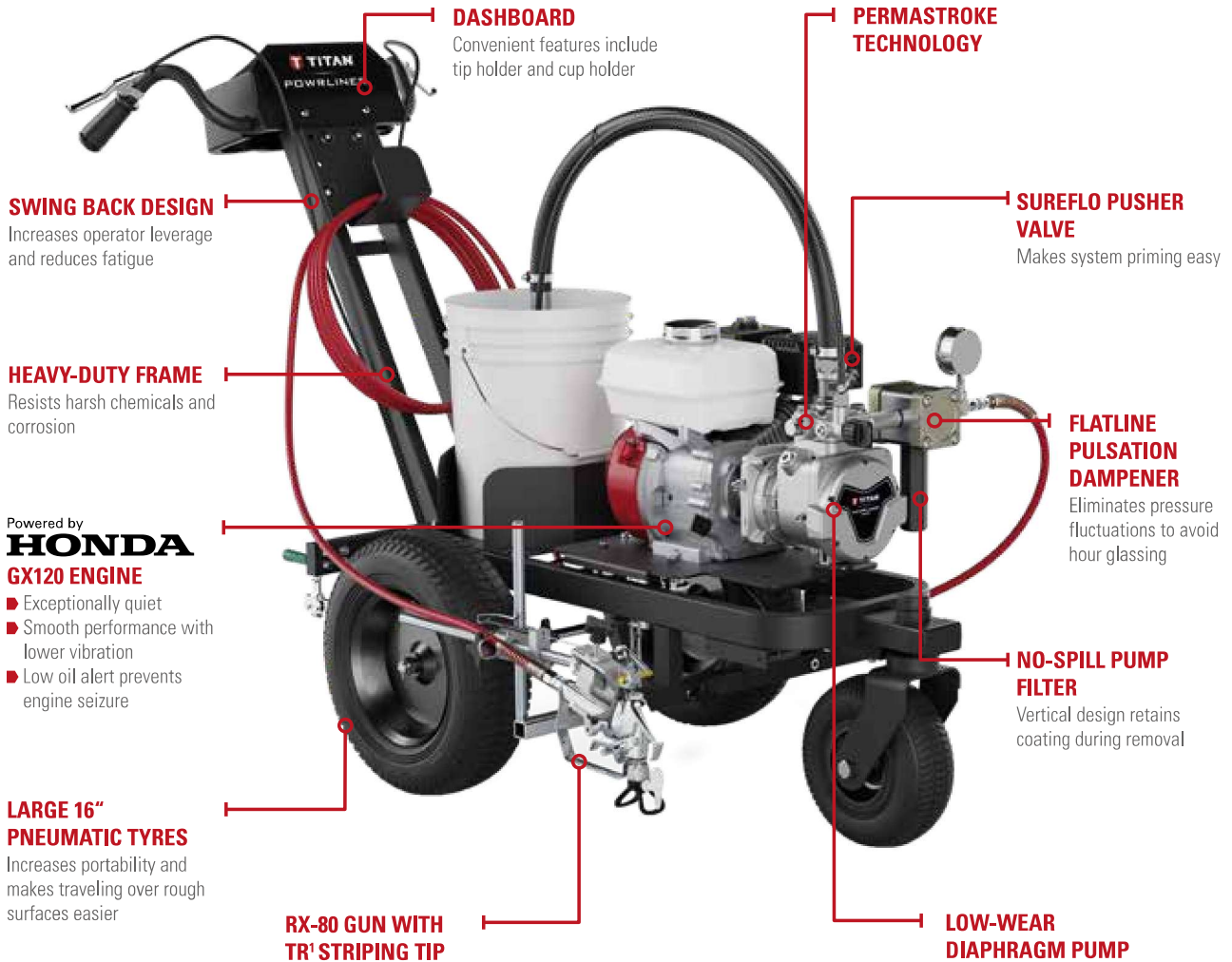

SPECIFICATIONS	POWRLINER 3500
Max. Delivery	2.8 l/min
Max. Tip Size - 1-Gun	0.027"
Max. Operating Pressure	228 bar / 22.8 MPa
Max. Viscosity	20000 mPas
Weight	87 kg
Engine / Motor	Honda GX120
Scope of delivery	PowrLiner 3500 base unit, RX-80 Gun, 419 TR' Line Striping Tip, 15 m x 1/4" Airless Hose and 517 SC-6+ Stenciling Tip
PART-NO.	0537015

POWRLINER 3500 72 V

The TITAN PowrLiner 3500 72V delivers even better lines than our gas-powered strippers thanks to the new Honda battery technology that greatly reduces vibration. Featuring the revolutionary PermaStroke Technology, which has no piston, packings,

cylinders, or clutch to replace, it is simple to operate and field serviceable, keeping contractors on the job.

DASHBOARD

Convenient features include tip holder and cup holder

SWING BACK DESIGN

Increases operator leverage and reduces fatigue

Powered by HONDA eGX MOTOR

Designed to closely meet the performance output of a conventional GX120 gas engine.

LARGE 16" PNEUMATIC TYRES

Increases portability and makes traveling over rough surfaces easier

Powered by **HONDA LITHIUM-ION BATTERY**
Removable and quickly rechargeable

FLATLINE PULSATION DAMPENER
Eliminates pressure fluctuations to avoid hour glassing

NO-SPILL PUMP FILTER
Vertical design retains coating during removal

RX-80 GUN WITH LINE STRIPING TIP



SPECIFICATIONS	POWRLINER 3500 72V
Max. Delivery	2.8 l/min
Max. Tip Size - 1-Gun	0.027"
Max. Operating Pressure	228 bar / 22.8 MPa
Max. Viscosity	20000 mPas
Weight (without battery)	84 kg
Engine / Motor	Honda eGX Motor
Scope of delivery	PowrLiner 3500 72V base unit, Honda 72V Battery (1 or 2 pcs.), Battery charger (EU-plug) RX-80 Gun, 419 TR1 Line Striping Tip, 15 m x 1/4" Airless Hose and 517 SC-6+ Stenciling Tip

PART-NO. (ONE BATTERY) 2445730E
PART-NO. (TWO BATTERIES) 2445730E2

POWRLINER 4500

The revolutionary PowrLiner 4500, built with technology that delivers a best in class line quality with sharp and consistent edges... even on the toughest surfaces. Designed to withstand the rigors of steady, everyday use on pavement, fields and turf. It's the perfect intermediate line striper for contractors who need

a maneuverable, medium-duty unit for projects where the big machines just aren't profitable to operate. Recommended for medium to large sized projects on all parking lots and athletic fields.

DEADLOCK HANDLEBARS

Infinitely adjustable in 3-planes

HEAVY-DUTY FRAME

Resists harsh chemicals and corrosion

Powered by HONDA GX160 ENGINE

- Exceptionally quiet
- Smooth performance with lower vibration
- Low oil alert prevents engine seizure

LARGE 16" PNEUMATIC TYRES

Increases portability and makes traveling over rough surfaces easier

STRIPING GUNS

Two RX-80 guns with premium 419 TR¹ striping tips

POWRCENTER DASHBOARD

Convenient and easy-to-use, including the pressure control knob, tip holder, and cup holder

PERMASTROKE TECHNOLOGY

SUREFLO PUSHER VALVE

Makes system priming easy

FLATLINE PULSATION DAMPENER

Eliminates pressure fluctuations to avoid hour glassing

NO-SPILL PUMP FILTER

Vertical design retains coating during removal

LOW-WEAR DIAPHRAGM PUMP

ADJUSTABLE ENGINE MOUNT PLATE

Optimizes weight distribution for walk-behind or LazyLiner use

SMARTARM

Pivots and lifts, making line adjustments and transportation quick and easy

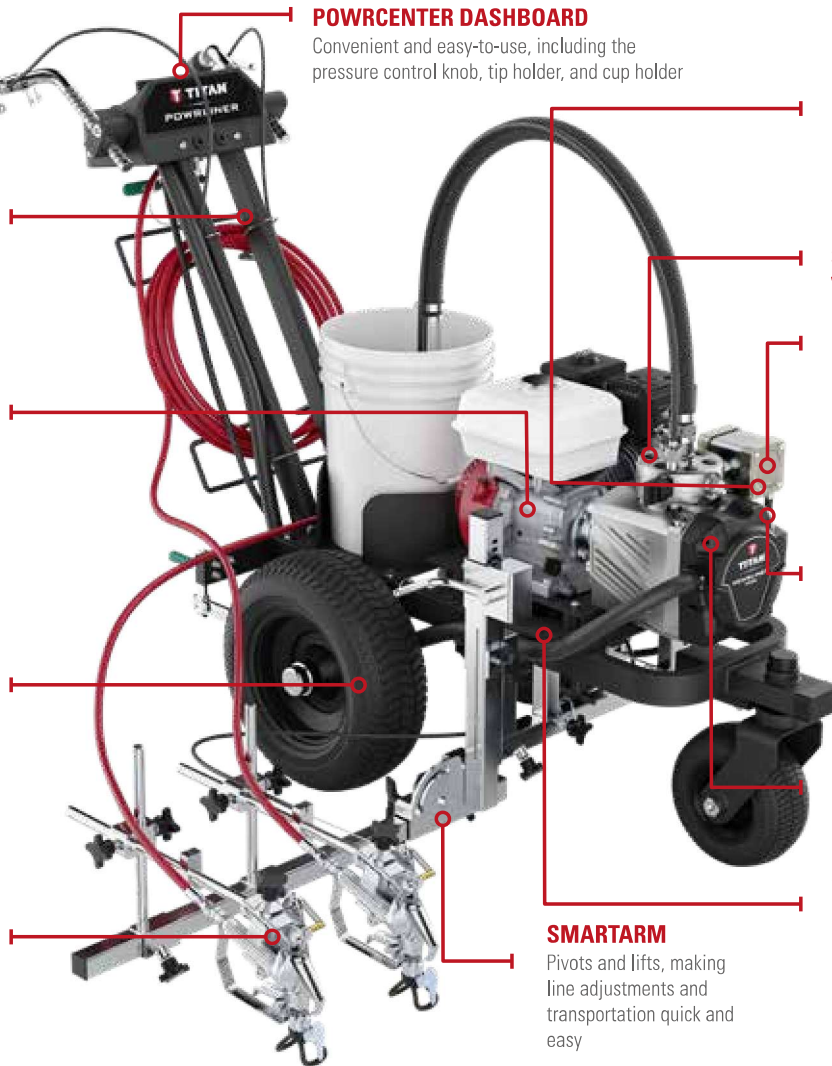

SPECIFICATIONS	POWRLINER 4500
Max. Delivery	4.7 l/min
Max. Tip Size - 1-Gun	0.036"
Max. Tip Size - 2-Gun	0.025"
Max. Operating Pressure	228 bar / 22.8 MPa
Max. Viscosity	20000 mPas
Weight	103 kg
Engine / Motor	Honda GX160
Scope of delivery	PowrLiner 4500 base unit, (2) RX-80 Spray Guns, (2) 419 TR ¹ Line Striping Tips, 15 m x 1/4" Airless Hose, 4 m x 1/4" Airless Hose, 2 m x 1/4" Airless Hose and 517 SC-6+ Stenciling Tip
PART-NO.	2407312

POWRLINER 4955

Designed and built for contractors who are serious about completing medium to large scale striping projects quickly and profitably. PowrLiner 4955 is the first step in hydraulic strippers

where power and long-term, heavy duty operation are the difference between a business that makes money and one that does not.

DEADLOCK HANDLEBARS

Infinitely adjustable in 3-planes

HEAVY-DUTY FRAME

Epoxy-finished frame resists harsh solvents and corrosion

CONVENIENT HOSE STORAGE

Keeps hose conveniently stored on the rear of the striper

45 LITRE PAINT HOPPER

LARGE 16" PNEUMATIC TYRES

Increases portability and makes traveling over rough surfaces easier

SECOND GUN KIT

Complete with S-3 gun, hose and tip kit for wider or dual lines.

POWRCENTER DASHBOARD

Convenient and easy-to-use, including the pressure control knob, tip holder, and cup holder

PRECISE PRESSURE CONTROL

From 27 to 227, for spraying lightbodied coatings all the way up to low- VOC striping paints.

SPEEFLO HYDRADRIVE

Provides extreme power and reliability

PETROL OR ELECTRIC DRIVEN

Easy, tool-free convertibility from petrolpower to electric power with separate available Electro Converter Kit (art.no. 0290117A) for projects where petrol engines are not permitted.

SMARTARM

Pivots and lifts, making line adjustments and transportation quick and easy



SPECIFICATIONS	POWRLINER 4955
Max. Delivery - Petrol	4.7 l/min
Max. Delivery - Electric	4.2 l/min
Max. Tip Size - 1-Gun	0.034"
Max. Tip Size - 2-Guns	0.024"
Max. Operating Pressure	227 bar / 22.7 MPa
Max. Viscosity	50000 mPas
Weight	147 kg
Engine / Motor	Honda GX120t
Scope of delivery	PowrLiner 4955 base unit, (2) S-3 Spray Guns, (2) 419 TR ¹ Line Striping Tips, SC-6+ 517 Stenciling Tip, 15 m x 1/4" Airless Hose, 2 m x 1/4" Airless Hose
PART-NO.	0290052H

POWRLINER 6955

Larger projects require more power and output. PowrLiner 6955 line strippers are the workhorse machines of the industry, designed for ease of use and simple operation on major projects

that require maximum performance with minimum downtime and maintenance. Recommended for large scale, full-time duty on airports, roads, parking lots and athletic fields.

DEADLOCK HANDLEBARS

Infinitely adjustable in 3-planes

HEAVY-DUTY FRAME

Epoxy-finished frame resists harsh solvents and corrosion

CONVENIENT HOSE STORAGE

Keeps hose conveniently stored on the rear of the striper

45 LITRE PAINT HOPPER

LARGE PNEUMATIC TYRES

Increases portability and makes traveling over rough surfaces easier

STRIPING GUNS

Includes S-3 Stainless Steel spray gun with premium TR¹ line striping tip.

POWRCENTER DASHBOARD

Convenient and easy-to-use, including the pressure control knob, tip holder, and cup holder

PRECISE PRESSURE CONTROL

From 27 to 227, for spraying lightbodied coatings all the way up to low- VOC striping paints.

SPEEFLO HYDRADRIIVE

Provides extreme power and reliability

Powered by HONDA GX160 ENGINE

- Exceptionally quiet
- Smooth performance with lower vibration
- Low oil alert prevents engine seizure
- Electric starter

SMARTARM

Pivots and lifts, making line adjustments and transportation quick and easy



SPECIFICATIONS	POWRLINER 6955
Max. Delivery - Petrol	8.5 l/min
Max. Tip Size - 1-Gun	0.050"
Max. Tip Size - 2-Gun	0.033"
Max. Operating Pressure	227 bar / 22.7 MPa
Max. Viscosity	50000 mPas
Weight	151 kg
Engine / Motor	Honda GX160
Scope of delivery	PowrLiner 6955 base unit, (2) S-3 Spray Guns, (2) 419 TR ¹ Line Striping Tips, SC-6+ 517 Stenciling Tip, 15 m x 1/4" Airless Hose, 2 m x 1/4" Airless Hose
PART-NO.	0290053H

POWRLINER 8955

The workhorse machines of the industry with even more delivery capacity for faster operation. The PowrLiner 8955 line striper makes it possible to handle even larger projects in less time. The PowrLiner utilize hydraulic pump technology for heavy-duty,

long-term use on medium, large and giant scale striping projects with maximum performance besides minimum downtime and low maintenance. Recommended for large scale, full-time duty on airports, roads, parking lots and athletic fields.

DEADLOCK HANDLEBARS

Infinitely adjustable in 3-planes

HEAVY-DUTY FRAME

Epoxy-finished frame resists harsh solvents and corrosion

CONVENIENT HOSE RACK

Keeps hose conveniently stored on the rear of the striper

45 LITRE PAINT HOPPER

LARGE PNEUMATIC TYRES

Increases portability and makes traveling over rough surfaces easier

STRIPING GUNS

Includes S-3 Stainless Steel spray gun with premium TR¹ line striping tip

POWRCENTER DASHBOARD

Convenient and easy-to-use, including the pressure control knob, tip holder, and cup holder

PRECISE PRESSURE CONTROL

From 27 to 227, for spraying lightbodied coatings all the way up to low- VOC striping paints

SPEEFLO HYDRADRIVE

Provides extreme power and reliability

Powered by HONDA GX200 ENGINE

- Exceptionally quiet
- Smooth performance with lower vibration
- Low oil alert prevents engine seizure
- Electric starter

SMARTARM

Pivots and lifts, making line adjustments and transportation quick and easy

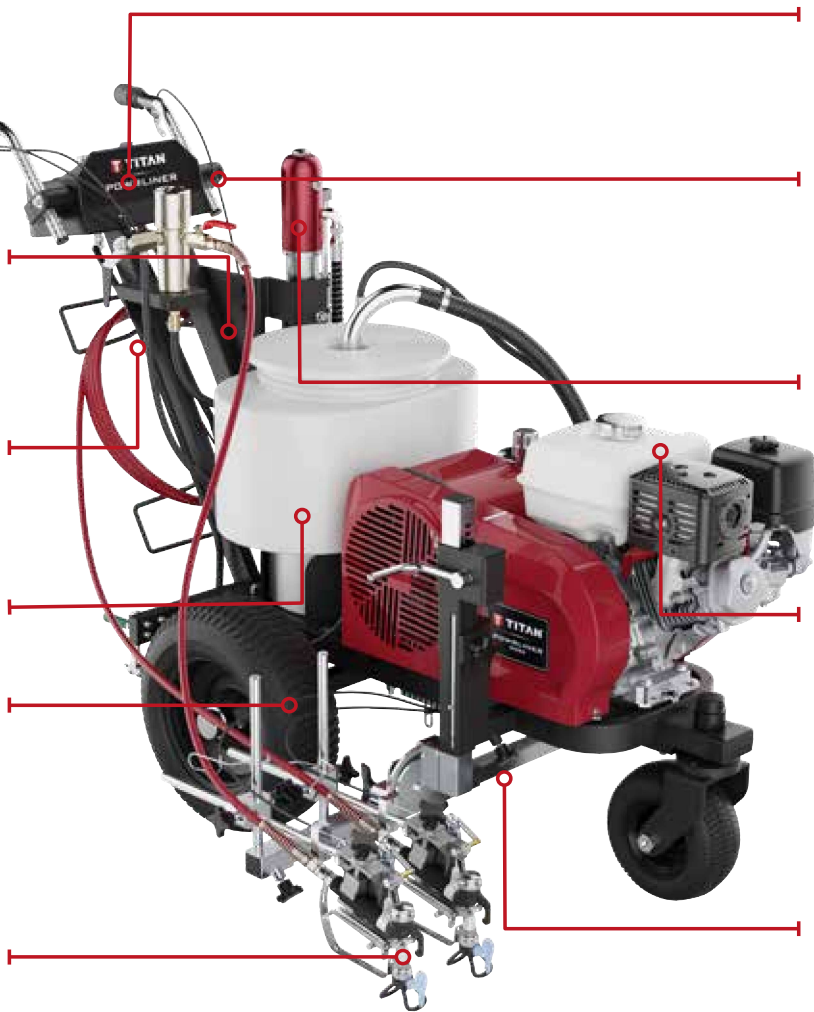

SPECIFICATIONS	POWRLINER 8955
Max. Delivery - Petrol	9.5 l/min
Max. Tip Size - 1-Gun	0.054"
Max. Tip Size - 2-Guns	0.038"
Max. Operating Pressure	227 bar / 22.7 MPa
Max. Viscosity	65000 mPas
Weight	154 kg
Engine / Motor	Honda GX200
Scope of delivery	PowrLiner 8955 base unit, (2) S-3 Spray Guns, (2) 419 TR ¹ Line Striping Tips, SC-6+ 517 Stenciling Tip, 15 m x 1/4" Airless Hose, 2 m x 1/4" Airless Hose
PART-NO.	0290054H



TITAN
POWRLINER
4500

TITAN
POWRLINER

POWRLINER



POWRMAX

The powerful screw pump is ideal for spraying plaster, as it easily handles highly viscous, heavy, coarse-grained, and fibrous materials. It is one of the most robust devices while

also being easy to operate. The screw pump stands out for its high working speed and excellent surface results while minimizing physical strain during use.

POWRMAX 420

The TITAN PowrMax 420 electric screw pump delivers the power required for large jobs with the versatility to spray up to 6 mm aggregate materials. With the TITAN PowrMax rotor stator sprayer, all plastering tasks can be carried out efficiently.

Weighing around 60kg, the PowrMax 420 is compact and has pneumatic tyres for easy manoeuvrability on worksites. It can be easily filled either by hand or with a continuous mixer.

FAST HANDLING OF BIG CONSTRUCTION SITE

Hopper with 50 litres capacity

COMPACT UNIT WITH HIGH POWER

Due to a strong brushless motor

VERSATILE OPERATIONS

Sprays fibrous, aggregate and water-based materials

COMPACT SIZE

Easy transport and high manoeuvrability on the construction site

HUGE WORKING RADIUS

Use up to 40m of plaster hose

EASY & FATIGUE-FREE HANDLING

Lightweight pneumatic spray lance



SPECIFICATIONS	POWRMAX 420
Operating pressure, max	40 bar / 4 MPa
Hopper volume	50 l
Delivery rate, max	20 l/min
Delivery height, max	20 m
Grain size, max	K6 mm
Weight	59 kg
Weight Spray lance	0.95 kg
Motor power	2.3 kW
Voltage	230 V ~, 50 Hz
Minimum required compressed air volume	320 l/min

Scope of delivery
Base unit PowrMax 420, Mortar hose DN25 incl. air hose, Spray lance (incl. 6 mm texture Tip), Cleaning balls & needle

PART-NO. 2451359



PROSTEP STEAMER

Steam wallpaper strippers are the quickest way to remove wallpaper sustainably without chemical additives. Whether multi-layered or coated the wallpaper is effortlessly removed

using the power of steam so the paper simply peels off the wall. This saves valuable time and effort while achieving professional results.

PROSTEP STEAMER

The TITAN ProStep Steamer is the quickest and easiest solution for removing all types of wallpaper. Thanks to the innovative flash-boil technology, it is ready for use in less than 4 minutes. The ProStep Steamer comes with two practical plate sizes: a small one for narrow areas and a larger one for the efficient

handling of large surfaces. Thanks to its high performance, several layers of wallpaper can be easily removed without leaving any residue. With its 5.1 litre tank and cleverly integrated storage compartments, the steamer is the ideal solution for professionals with regular use and for rental companies.

FLASH BOIL TECHNOLOGY

Fast heating of the water in under four minutes

INTEGRATED STEP

Hard-to-reach places can be worked on without a ladder

5.1 L WATER TANK

Removable for easy filling

WATER LEVEL INDICATOR

Provides information about the current fill level

DESCALING LIGHT

Indicates the time for descaling



SPECIFICATIONS	PROSTEP STEAMER
Voltage	230 V~, 50 Hz
Heat-up time	under 4 min
Step load capacity	150 kg
Container volume	5.1 l
steaming time, max.	78 min
Power / heat output max.	2750 W
Steamer plate dimensions	321 x 242 mm and 150 x 75 mm
Power cable length	5 m
Hose length	5 m
Weight	7.5 kg
Scope of delivery	ProStep Steamer base device, 5 m hose, Large steamer plate, small steamer plate
PART-NO.	2449630



ACCESSORIES

When your business depends on the tools you use, you need to be able to count on each part of your tools. TITAN offers you a wide range of accessories, from small wear parts such as filters or tips to practical accessories to extend the application possibilities of your machine.

JETFORCE & HVLP ACCESSORIES

Ideal suitable for all Focus 500, Focus 700 sprayers, Capspray and FlexSpray sprayers.



FLEXFINISH PRO

Recommended for all standard enamels and emulsion paints

4.1 mm flat jet nozzle

1000 ml aluminium container

Standard feed tube;
feed tube filter fine;
feed tube filter coarse

PART-NO. 2444251



FINEFINISH PRO

Recommended for varnishes, wood stains, undercoats

1.8 mm round nozzle

1000 ml aluminium container

Standard feed tube;
2x feed tube filter fine

PART-NO. 2444249

FRONT ENDS

The flexible front ends can be changed quick and easy with just a few moves. Thanks to the plug 'n' spray technology you are well prepared for every projects. Perfectly suited for Focus and FlexSpray Pro spray systems.



ACCESSOIRES

MAXUM ELITE GUN

For contractors and finishing professionals who expect flawless results with the versatility to use gravity- or siphon-fed cup gun.

- ▶ Removable and reversible fluid chamber design enables use with standard pressurized cup and pressurized gravity cup
- ▶ Stainless steel fluid passages
- ▶ Fluid needle stays with packing and head assembly for colour and tip size changes—allows for easier storage and clean up
- ▶ Integrated check valve in gun head
- ▶ Patented grip design for stay-cool operation
- ▶ Multi-position pick-up tube for spraying at various angles
- ▶ Comes standard with a #3 Proset (Needle set)



▶ Maxum Elite Gun with Gravity Cup and Stand



▶ Maxum II Gun

MAXUM III GUN

Ideal for solvent and water based standard paints

- ▶ Quick-release coupling with integrated swivel joint for quick connection of the gun to the air hose
- ▶ Precise adjustment of the spray pattern



▶ Maxum Elite Gun



▶ Maxum III Pro Gun

MAXUM II GUN

For maximum control and pinpoint-accurate coating delivery, the Maxum II is an excellent choice for contractors and finishing professionals who need a precise fine finishing tool.

- ▶ Ability to convert from non-bleeder to bleeder gun
- ▶ Comes standard with a #3 Proset (Needle set) and 950 ml cup

MAXUM ELITE GUN	PART-NO.
Maxum Elite Gun with 1l Cup	0524027
Maxum Elite Gun with Gravity Cup	0524052

MAXUM ELITE ACCESSORIES	PART-NO.
Pressure-Fed 1l Cup	0524271 A
Gravity Cup Accessory with Stand	0524045

MAXUM II GUN	PART-NO.
Maxum II Gun with Pressure-Fed 1l Cup	0524041

MAXUM III PRO GUN	PART-NO.
Maxum III Pro Gun with Pressure-Fed 1l Cup	2439421

PROJECTOR SETS	MAXUM II	MAXUM ELITE
#2 Projector Set (Fine Finish)	0276254	0524293
#3 Projector Set (All-Purpose)	0276227	0524294
#4 Projector Set (High Output)	0276228	0524295
#5 Projector Set (High Output)	0276229	0524296
#6 Projector Set (High Output)	0276245	0524297
#7 Projector Set (Highest Output)	0524211	0524298



Maxum II ▶
Standard Kit



White, ▶
950 ml Cup
Petrokets



Gun Repair Kit
for Maxum II ▶
Gun



GUN REPAIR KITS / PARTS

PART-NO.

Replacement Check Valve Assemblies (3-pack)	0297051
Check Valve Seals (10-Pack)	0276257
Gun Repair Kit for Maxum II Gun	0277943
Gun Repair Kit for Maxum Elite Gun	0524187
Spring Plate Assembly	0275250

MAINTENANCE KITS

MAXUM II MAXUM ELITE

Standard Kit	0279942	0524188
--------------	---------	---------

REPLACEMENT TURBINE FILTERS

PART-NO.

Air Filter Kit (Qty. 4) Capspray X80	2434505
Air Filter Kit (Pleated) Capspray 105 Atomizing Air	0524523 A
Pre-Filter Kit (Qty. 2) Capspray 105	0524526 A
Filter	0524528 A

CUPS AND ACCESSORIES

PART-NO.

1l Cup Assembly with Swivel Tube	0277183
1l Replacement Cup	0275573
Gravity Cup Assembly with Stand	0524045
White, 950 ml Cup Petrokets, Hot Solvents (6-pack)	0297052

1.9 L REMOTE CUP

Transform your turbine system into a high-capacity sprayer without adding the cost and weight of a bulky air compressor.

For use with Capspray X80 and 105 sprayers. 1.5 m Air whip hose sold separately.



PART-NO.

1.9 l Remote Cup	0524203
------------------	---------



Flex Air ▶
Hose

PART-NO.

9 m x 3/4" Flex Air Hose	0277337
1.5 m x 3/4" Air Whip Hose	0524405 A
Quick Disconnect (F) Turbine	0275625

CONTROLMAX ACCESSORIES

Ideal accessories for Controlmax

TIP



HEA TIP

- The HEA airless tip achieves optimum surface results with reduced spray pressure
- Fits on TITAN ControlMax

	ART.NR
HEA Tip 211	330-211
HEA Tip 311	330-311
HEA Tip 313	330-313
HEA Tip 413	330-413
HEA Tip 515	330-515
HEA Tip 517	330-517
HEA Tip 619	330-619

GUN



HEA PRO METALL-GUN

- Highly efficient metal airless gun
- Soft trigger and comfortable grip
- Fits on TITAN ControlMax

	ART.NR
HEA Pro Metall gun with HEA 517 Tip	353-701

EXTENSION



EXTENSION

- Tip extension - for more comfortable working and better reach
- Fits on TITAN ControlMax

	ART.NR
Extension 30cm	580437

HOSE



	ART.NR
HEA 50" (m/f) hose	353-708

AIRLESS ACCESSORIES

Accessories for Compact, Impact, Elite, PowrBeast, PowrTwin and Hydra sprayers.



RX-80 AIRLESS SPRAY GUN

- Comes with two or four-finger trigger
- Pressure rated at 248 bar (24.8 MPa)



Comfort Grip

Ergonomic design brings added comfort.



Longer Life Packing Kit

Lasts longer with improved performance.



Onboard Tools

Smart tools that make jobsite life easier. Built-in Filter Removal Tool.

PART-NO.

RX-80 Airless Gun, Four-Finger with SC-6+ 517	0538007
RX-80 Airless Gun, Two-Finger with SC-6+ 517	0538008
RX-80 4-Finger Gun, Hose and Tip w/ SC-6+ 517 *	0538011

*Includes additional 0.9 m whip hose and a 2-finger trigger.



3 Grip Sizes Available

RX-PRO AIRLESS SPRAY GUN

- Comes with both two and four-finger trigger
- Pressure rated at 248 bar (24.8 MPa)



Ultra-light Trigger

30% lighter than the competitors trigger pull decreasing fatigue.



FingerPrint Grip

Customize the grip to comfortably fit any painter's hand.



Infinity Packing

2X the gun life by reversing the seat and changing the ball.



Onboard Tools

Smart tools that make jobsite life easier. Built-in Filter Removal Tool.

FINGERPRINT GRIP CUSTOMIZABLE TO YOUR HAND SIZE.

PART-NO.

Small	0538217
Medium	0538218
Large	0538219

PART-NO.

RX-Pro Airless Gun with TR1 HEA 517 Tip	0538020
RX-Pro Gun, Hose, Whip & 517 Tip Kit	0538022

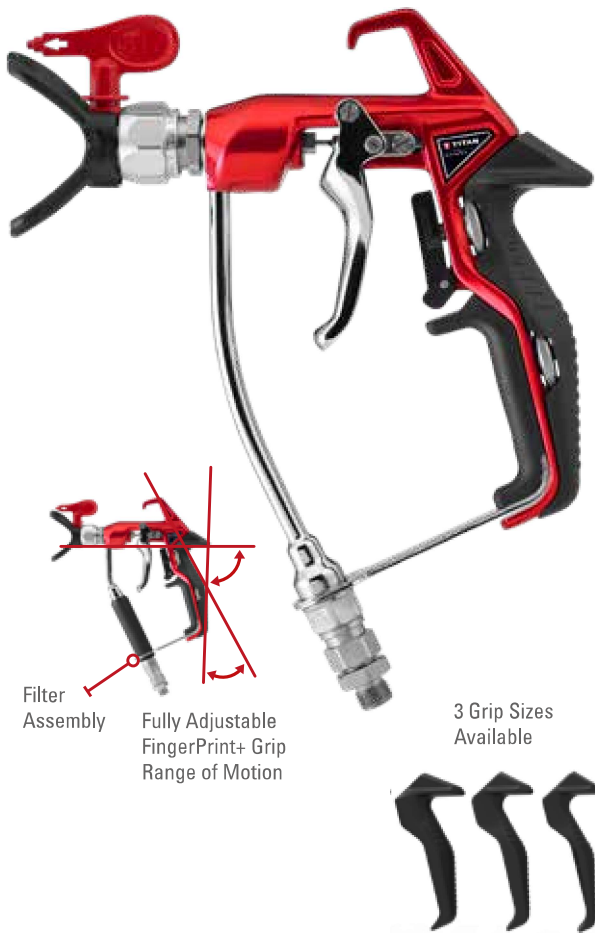

Filter Assembly Fully Adjustable FingerPrint+ Grip Range of Motion

3 Grip Sizes Available

S-SERIES: SPRAY SPECIALIZED COATINGS WITH EASE

S-3 AIRLESS GUN

- In-handle filter
- Easy four-finger trigger pull
- 1/4" swivel reduces hose kinks
- Pressure rated at 269 bar (26.9 MPa)



	PART-NO.
S-3 Gun with TR ¹ 517 Tip	0550060

RX-APEX AIRLESS SPRAY GUN

- Comes with two-finger trigger
- Pressure rated at 345 bar (34.5 MPa)
- Stainless Steel Direct Feed (Non-Filtered Shown)

- 24 All-Day Trigger**
28% lighter trigger pull force and 74% less hold force.
- FingerPrint+ Grip**
Fully adjustable grip delivers maximum customization.
- 2X LIFE Infinity Packing**
2X the gun life by reversing the seat and changing the ball.
- Free-Flow Swivel**
Only direct feed airless gun with built-in swivel.

FINGERPRINT+ GRIP CUSTOMIZABLE TO YOUR HAND SIZE	PART-NO.
Small	0538247
Medium	0538248
Full	0538256

	PART-NO.
RX-Apex, Non-Filtered Airless Gun with TR ¹ 517 Tip	0538070
RX-Apex, Filtered Airless Gun with TR ¹ 517 Tip	0538075

S-7 AIRLESS GUN

- In-handle filter
- Easy four-finger trigger pull
- Pressure rated at 531 bar (53.1 MPa)
- Includes 517 TR¹ high pressure, heavy-duty reversible tip and guard
- Available in two swivel sizes, swivel reduces hose kinks



	ART.NR
S-7 Gun with 1/4" Swivel	550-260
S-7 Gun with 3/8" Swivel	550-270

FROM LOW-VISCOSITY MATERIALS TO HEAVY, HIGH-VISCOSITY COATINGS



■ M-4 Mastic Gun

M-4 AND M-8 MASTIC GUNS

- Straight line fluid passage allows max flow rate
- Angled handle for increased comfort
- Adjustable needle packing prolongs the life of critical wear parts
- Swivel allows freedom of movement without hose kinking
- Lightweight metal construction

		PART-NO.
M-4 Mastic Gun	248 bar (24.8 MPa)	0289013
M-8 Mastic Gun	531 bar (53.1 MPa)	0289014

FOR TEXTURED APPLICATIONS



SPLATTER NOZZLE

- For smooth texture applications including orange peel and knock down. For best results use with M Series Airless Guns. Air requirement 4-12 CFM at full open.

		PART-NO.
Splatter Nozzle		765-360



ACCESSOIRES

THE INDUSTRY LEADER IN TIP TECHNOLOGY

Airless spray tips are a key component to the successful operation of an airless spray system. They define the spray pattern, control the flow, atomize the coating and ultimately tell the pump how hard it must work. A proper understanding of airless tips is critical to the success of any airless application.

TIP CHARACTERISTICS

It is important to remember that the orifice size, in conjunction with the fan-width, determines the spray characteristics of the tip.

TIP WEAR

When beginning a project, choosing the right tip size and fan width will determine both coating consumption and production time. If the tip size is wrong — either by choice or through wear — mil thicknesses will be too heavy and the finish will be unprofessional.

The spray pattern chart demonstrates what happens as a tip wears. As wear occurs, the pattern size decreases and the orifice size increases. You will have to make more passes to cover the same area. There is no standard rate of tip wear due to the variation of the abrasiveness of all coatings.



EXAMPLES FOR UNDERSTANDING AIRLESS TIPS

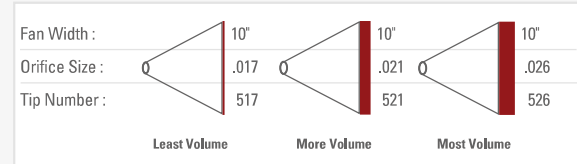

EXAMPLE A:

The larger the orifice with the same fan width, the greater the volume of paint applied to the area.

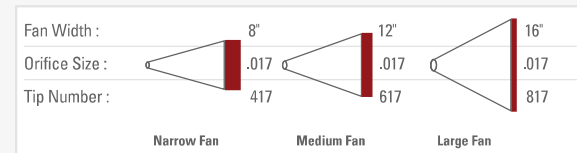

EXAMPLE B:

The larger the fan width with the same orifice means the same amount of material is being applied over a greater area. The result is less volume of paint per square inch.

HOW A TIP FAN PATTERN TYPICALLY WEARS

SC-6+ WITH 517 TIP			
SPRAY PATTERN WIDTHS			
New 517	Worn to 419	Worn to 321	Worn to 223
FLOW RATES			
1.17 l/min	1.47 l/min	1.78 l/min	2.15 l/min
FLOW RATE INCREASE			
0 %	26 %	52 %	84 %

TR ¹ WITH 517 TIP			
SPRAY PATTERN WIDTHS			
New 517	Worn to 519	Worn to 521	Worn to 523
FLOW RATES			
1.17 l/min	1.47 l/min	1.78 l/min	2.15 l/min
FLOW RATE INCREASE			
0 %	26 %	52 %	84 %

PREMIUM TR¹ REVERSIBLE TIP

- The best overall performing tip in the industry
- Fan pattern stays wider longer
- An orifice that outlasts competitive tips delivering consistent film thickness and less wasted paint
- Fits all TITAN and most other industry spray gun guards



TR¹ HIGH PRESSURE TIPS 696-XXX

PROVEN RESULTS IN A 380 LITERS TEST TITAN TR¹ TIP VS. THE COMPETITOR'S PREMIUM TIP

TITAN TR¹ Spray-out Test

Competition Spray-out Test

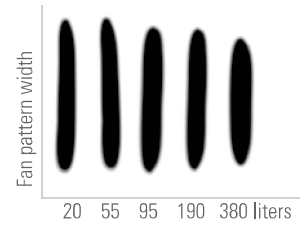
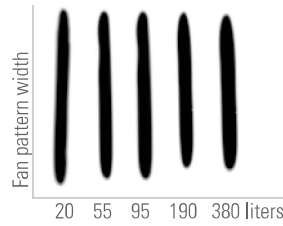

TITAN's TR¹ tip has a consistently wide fan pattern and an orifice that outlasts the competition making it the best performing tip in the industry.

Fan pattern does not stay wide as long as the TR¹.

ORIFICE SIZE (INCHES)

FAN PATTERN WIDTH	INCHES		ORIFICE SIZE (INCHES)																				
	INCHES	MM	.007	.009	.011	.013	.015	.017	.019	.021	.023	.025	.027	.029	.031	.033	.035	.037	.039	.043	.045	.055	
2-4	51-102	107	109	111	113	115	117	119															
4-6	102-152		209	211	213	215	217	219	221	223	225	227											
6-8	152-203		309	311	313	315	317	319	321	323	325	327	329	331	333	335	337	339					
8-10	203-254		409	411	413	415	417	419	421	423	425	427	429	431	433	435		439	443	445	455		
10-12	254-305		509	511	513	515	517	519	521	523	525	527	529	531	533	535	537	539	543	545	555		
12-14	305-356		609	611	613	615	617									627							655
14-16	356-406						717	719	721	723	725	727		731	733	735							
16-18	406-457						817	819	821								835	837	839	843			
18-20	457-508									923	925	927		931			937						
Flow (GPM)	---		0.05	0.09	0.13	0.18	0.24	0.31	0.39	0.47	0.57	0.67	0.78	0.91	1.03	1.17	1.32	1.40	1.64	1.99	2.18	3.26	
Flow (l/min)	---		0.19	0.34	0.45	0.68	0.91	1.17	1.47	1.78	2.15	2.53	2.95	3.44	3.89	4.42	4.99	5.29	6.20	7.52	8.24	12.32	

Maximum Working Pressure: 531 bars (53.1 MPa)

TR¹ LINE STRIPING TIPS 697-XXX



ORIFICE SIZE (INCHES)

FAN PATTERN WIDTH	INCHES		ORIFICE SIZE (INCHES)												
	INCHES	MM	.013	.015	.017	.019	.021	.023	.025	.027	.029	.031	.035	.039	.043
2	51		213	215	217	219									
4	102		413	415	417	419	421	423	425	427	429	431	435	439	443
6	152			615	617	619	621	623	625	627	629	631	635	639	643
8-10	203-254						821	823	825	827	829	831	835	839	843
Flow (GPM)	---		0.18	0.24	0.31	0.39	0.47	0.57	0.67	0.78	0.91	1.03	1.32	1.64	1.99
Flow (l/min)	---		0.68	0.91	1.17	1.47	1.78	2.15	2.53	2.95	3.44	3.89	4.99	6.20	7.52

Maximum Working Pressure: 345 bars (34.5 MPa)

TR¹ HEA TIP



Perfect for interior and exterior residential and commercial wall spraying.



THE RIGHT MIX FOR PRODUCTION 330-XXX

		ORIFICE SIZE (INCHES)							
		INCHES	MM	.011	.013	.015	.017	.019	.021
FAN PATTERN WIDTH	4-6		102-152	211	213				
	6-8		152-203	311	313				
	8-10		203-254	411	413	415	417		421
	10-12		254-305			515	517	519	521
	12-14		305-356			615	617	619	621
	Flow (GPM)	---		0.09	0.12	0.18	0.24	0.31	0.47
Flow (l/min)	---		0.34	0.45	0.68	0.91	1.17	1.79	

Maximum Working Pressure: 345 bar (34.5 MPa)

HEA | HIGH EFFICIENCY AIRLESS™

REVOLUTIONARY LOW PRESSURE TECHNOLOGY

- Optimized to spray all architectural paints and coatings at 70 bar at production speed
- Decreases overspray up to 55% allowing contractors to spray more
- Less pressure equals less stress extending pump life and extending time between repacks
- Two times the life of a standard reversible tip
- Patented design

HIGHLY EFFICIENT FAN PATTERN

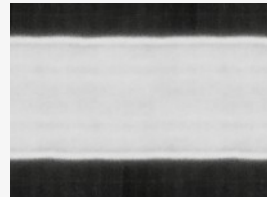

Latex emulsion paint through a standard 517 tip at 70 bar

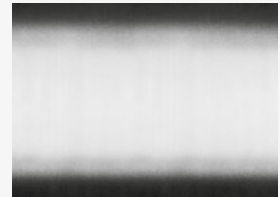

Latex emulsion paint through a HEA 517 tip at 70 bar

- Feathered edge provides consistent coverage
- More forgiving pattern that decreases runs and drips
- Less kickback when triggered providing more control and less overspray
- Fits all industry standard guards

MAXIMIZE THE PERFORMANCE OF YOUR HEA TIP



HEA Gauge Assembly Kit 0580495

HIGH QUALITY SC-6+ REVERSIBLE TIP

- ▶ The industry's longest-lasting orifice
- ▶ Up to 22% wider fan pattern
- ▶ Fits all TITAN and most industry standard guards

SC-6+ SYNERGY FINE FINISHING TIPS 671-XXX

FAN PATTERN WIDTH	INCHES	MM	ORIFICE SIZE (INCHES)			
			.008	.010	.012	.014
4-6		102-152	208	210	212	214
6-8		152-203	308	310	312	314
8-10		203-254	408	410	412	414
10-12		254-305		510	512	
12-14		305-356			612	
Flow (GPM)	---		0.07	0.11	0.16	0.21
Flow (l/min)	---		0.26	0.42	0.60	0.79

Maximum Working Pressure: 345 bar (34.5 MPa)



SC-6+ TIPS 662-XXX

FAN PATTERN WIDTH	INCHES	MM	ORIFICE WIDTH (INCHES)																			
			.007	.009	.011	.013	.015	.017	.019	.021	.023	.025	.027	.029	.031	.033	.035	.039	.043	.045	.051	.055
2-4		51-102	107	109	111	113	115	117														
4-6		102-152	207	209	211	213	215	217	219	221	223	225	227	229	231	233	235					
6-8		152-203	307	309	311	313	315	317	319	321	323	325	327	329	331	333	335					
8-10		203-254	407	409	411	413	415	417	419	421	423	425	427	429	431	433	435	439	443	445	451	455
10-12		254-305		509	511	513	515	517	519	521	523	525	527	529	531	533	535	539	543	545	551	555
12-14		305-356		609	611	613	615	617	619	621	623	625	627	629	631	633	635	639	643	645	651	655
14-16		356-406							719	721					731	735						
16-18		406-457								821						831						
Flow (GPM)	---		0.05	0.09	0.13	0.18	0.24	0.31	0.39	0.47	0.57	0.67	0.78	0.91	1.03	1.17	1.32	1.64	1.99	2.18	2.80	3.26
Flow (l/min)	---		0.19	0.34	0.45	0.68	0.91	1.17	1.47	1.78	2.15	2.53	2.95	3.44	3.89	4.42	4.99	6.20	7.52	8.24	10.58	12.32

Maximum Working Pressure: 345 bar (34.5 MPa)

TITAN TIPS PAINT MORE

TITAN Tips Vs. the Competition

Long-lasting orifice gives you more usable tip life, spraying a consistent film thickness and wasting less paint.



ACCESSOIRES

A GUARD FOR EVERY TIP

TITAN tip guards are designed to maximize airflow with minimal overspray. With a guard for every tip and the universal fitting which matches most industry standard guns we have you covered.



■ No Build



■ High Pressure

NO BUILD GUARD (7/8")

Aerodynamic dimple design allows for better airflow and less paint build up. Seal cavity on safety guard has large "flats" for quick and easy installation of seal.

- Rotate guard without loosening from gun
- No tools needed for installation
- Interchangeable with most industry spray guns
- Pressure rated at 345 bar (34.5 MPa)

	PART-NO.
No build guard	0289228

HIGH PRESSURE TIP GUARD (7/8")

- Interchangeable with most industry spray guns
- Pressure rated at 531 bar (53 MPa)

	PART-NO.
High pressure tip guard	661-027

SEALS



	PART-NO.
Metal Retainer	651-040
Black Seal, Latex	651-042
White Seal, Solvent Resistant	651-020
White Seal, Solvent Resistant (6-pack)	661-021
Seal and Retainer Kit, Solvent Resistant (5-pack)	661-020
Seal and Retainer Kit, Solvent Resistant (12-pack)	651-060
Gasket, 1/16" (12-pack)	711-606

SWIVEL

TITAN swivel joints make working with sprayers easier by ensuring comfortable hose handling



MICRO SWIVEL

The Micro Swivel can be used between the sprayer and hose, hose and hose, or hose and gun to eliminate kinking and damage to your spray hose. Its stainless-steel construction allows for use with all materials and it provides full 360° rotation even under high pressure making hose management safer and easier.

- Maximum pressure is 517 bar / 51.7 MPa
- Available in 1/4" or 3/8" sizes

	PART-NO.
Micro Swivel 1/4"	2454970
Micro Swivel 3/8"	2454971



EZ-SWIVEL

TITAN's EZ-Swivel provides infinite range of motion for your gun allowing you to spray in all of those hard-to-reach places without binding your hose. Spray longer, spray smarter, spray better — it's just that EZ.

- Stainless-steel construction for use with all spray materials
- Maximum pressure is 517psi / 51.7 MPa
- Available in 1/4" size

	PART-NO.
EZ-Swivel 1/4" x 1/4"	2454975

FILTERS

Nothing destroys a piston or a gun tip faster than debris in the coating. That's why you need the best paint filters available. TITAN gun filters and manifold filters are designed for long life and maximum protection.

They are made from stainless steel for strength and service. We offer a wide variety of mesh sizes from 0 to 150.

PUMP MANIFOLD FILTERS

	FOR USE ON IMPACT 410-1140; 640IX- 1140IX AND ELITE 3500	FOR USE ON POWRTWIN 4900, 5500, 6900, 8900, 10000 AND 12000 PLUS. POWRBEAST 4700/7700/9700	FOR USE ON HYDRA	FOR USE ON ALL 10" POWRcoat MODELS	FOR USE ON TITAN E15, E20, G40 AND G55
MESH	PART-NO.	PART-NO.	PART-NO.	PART-NO.	PART-NO.
0 COARSE		930-004			
5		930-005	920-001		
30	730-067-30				761-042
50*		930-006	920-004		
60	730-067			0533514	
100 EXTRA FINE	730-067-10	930-007	920-005		

* Standard with sprayer, excludes ball. Ball check sold separately (920-103).

GUN AND PUMP FILTERS

Unthreaded and threaded filter design for quick and easy replacement.

	UNTHREADED		THREADED	
	FOR USE WITH RX-PRO, RX-80, G-10, LX-30, LX-40, LX-50, LX-70, S-3 AND S-7..			
	BULK	2-PACK	BULK	2-PACK
Coarse (Green)*	581-059	0089957	540-030	500-200-03
Medium (White)	581-060	0089958	540-060	500-200-06
Fine (Yellow)	581-062	0089959	540-100	500-200-10
Extra Fine (Red)	581-061	0089960	540-150	500-200-15

*Manifold filter for Advantage 400, 440i and Impact 400.

IN-LINE FILTER Designed for added filtration or when using a gun without a filter.

	PART-NO.
In-Line Filter	550-223



INLET SCREENS

SMALL			LARGE			HYDRAULIC AND PNEUMATIC	
MESH	BULK PART-NO.	PACKAGED PART-NO.	MESH	BULK PART-NO.	PACKAGED PART-NO.	PART-NO.	
30 mesh (Fine)	700-900	700-900A	30 mesh (Fine)	710-191	710-191A	PowrTwin 4900, 6900, 8900, 12000 Plus and XLT	0509762A
10 mesh (Coarse)	700-805	700-805A	10 mesh (Coarse)	710-046	710-046A	All GHD	710-046A
30 mesh (Male)	----	0552947*				Hydra Pro IV	0509762A
						PowrCoat 10" (30 Mesh)	0533968

*Only for PowrLiner 550 and 850

FOR EVEN MORE RANGE

- ◆ Maximize the speed and efficiency of your operation
- ◆ Minimize danger – eliminate reaching from ladders
- ◆ Get the job done safely and quickly the first time
- ◆ Paint easily from a safe distance, keeping yourself and clothing clean



ALUMINIUM TIP EXTENSIONS

Our aluminium tip extensions are lightweight and easy to handle and can be used with all 7/8" thread airless spray guns.

- ◆ Pressure rated at 248 bar (24.8 MPa)
- ◆ 7/8" x 14 Thread is Standard

	PART-NO.
12.5 cm	2418848
25 cm	2418850
50 cm	2418851
75 cm	2418852

SPRAYGUIDE

May your lines be straighter and your profits greater! This unique freewheeling disc glides smoothly over virtually every surface.

Cut-in around windows, doors, trim and more without time - consuming prep work.

- ◆ Eliminates time-consuming masking or cutting in with a brush
- ◆ Attaches to a gun extension or an extension pole (sold separately) decreasing ladder work
- ◆ Best if used with a 411 tip. (Not included)
- ◆ Pressure rated at 248 bar (24.8 MPa)

	PART-NO.
SprayGuide Complete Kit	0538900
SprayGuide Replacement Arm and Disk Only	0538902

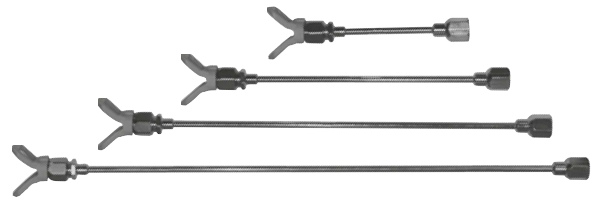

HIGH PRESSURE ALLOY STEEL TIP EXTENSIONS

When you need something a little more heavy duty. Can be used with all 7/8" thread airless spray guns.

- ◆ Pressure rated at 531 bar (53.1 MPa).
- ◆ 7/8" x 14 Thread is Standard

	PART-NO.
10" (25 cm)	2442148
20" (50 cm)	2442149
30" (75 cm)	2442150

EXTENSION POLE

These lightweight aluminum extensions are constructed with inner core ribs which reinforce the poles and greatly increase their rigidity. The inner core rib construction allows different length poles to be easily coupled together up to 12', while maintaining the proper rigidity to suit most job conditions.

- Reach high out-of-the-way places when spray or pressure rolling
- Adapts to most airless guns
- Includes Extension Pole Coupling (0509908)
- Pressure rated at 248 bar (24.8 MPa)

	PART-NO.
3' (0.9 m) Pole	2418862
6' (1.8 m) Pole	2418858



LX-75 IN-LINE GUN

- All metal construction
- A natural extension to any pole
- In-handle filter
- Swivel reduces hose kinks and ensures effortless control
- Pressure rated at 248 bar (24.8 MPa)

	PART-NO.
LX-75 IN-LINE Gun	550-475



SWIVEL HEAD

TITAN's new easy turn swivel rotates 260 degrees for greater versatility and accessibility.

- Pressure rated at 248 bar (24.8 MPa)

	PART-NO.
7/8" x 14 Thread Swivel Head - Female	0538029
7/8" x 14 Thread Swivel Head - Male	711-600

1.8 M OUTRIGGER GUN

Convert existing gun to 1.8 m pole gun and back in seconds. Outrigger allows you to increase production and profits. No additional hoses or fittings required.

- Constructed of lightweight and rigid aluminum to reduce arm fatigue
- Large gun installation holder and knob
- Adapts to all TITAN airless spray guns and most manufacturers' airless spray guns

	PART-NO.
1.8 m Outrigger	757-920

LX-75 POLE GUN

Reach those high, out-of-the-way places that normally require the use of a ladder or scaffolding.

- All metal construction
- Full-length needle ensures positive shut-off at tip
- Gun swivel and In-handle filter
- Pressure rated at 248 bar (24.8 MPa)

	PART-NO.
LX-75 Pole Gun	550-495

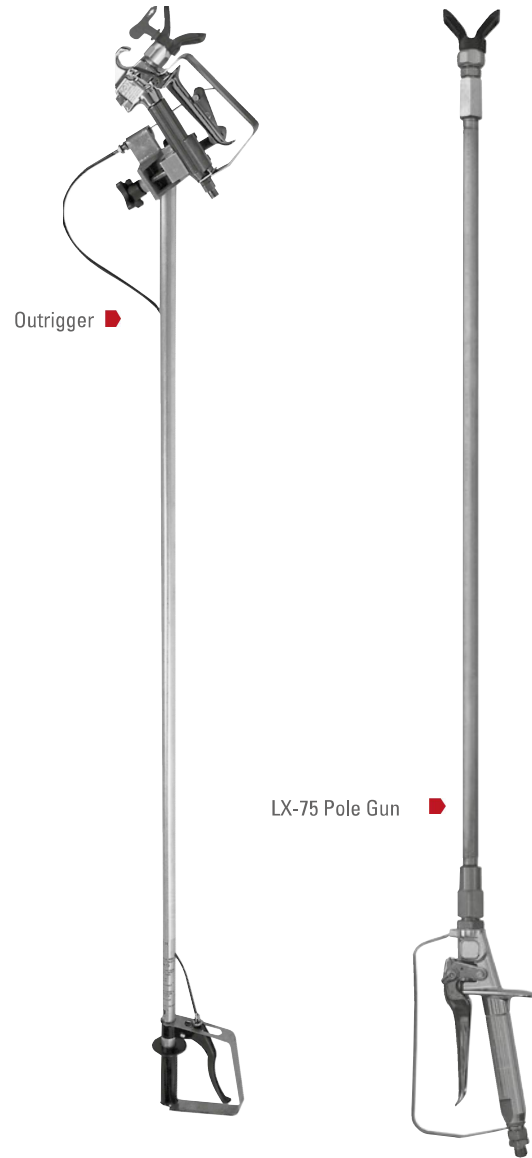

Angle Adapter Assembly



Extension Pole Coupling

ANGLE ADAPTER ASSEMBLY

Adapt any extension pole to any standard airless gun. Because of its right-angle design, the angle adapter allows the pole to extend from the gun at the same angle as the handle. The result is greater efficiency and comfort.

- Pressure rated at 248 bar (24.8MPa)

	PART-NO.
Angle Adapter Assembly	0509907

EXTENSION POLE COUPLING

Allows you to connect different length extruded poles together to create different lengths for any application. (Do not exceed 30 cm)

	PART-NO.
Extension Pole Coupling	0509908

THE RIGHT EQUIPMENT FOR THE JOB



HIGH QUALITY AIRLESS FLUID HOSES AND WHIP HOSES

INNER DIAMETER	LENGTH METERS	MAX. WORKING PRESSURE - BAR (MPA)					END CONNECTION
		228 (22.8)	248 (24.8)	310 (31.0)	448 (44.8)	517 (51.7)	
		PART-NO.	PART-NO.	PART-NO.	PART-NO.	PART-NO.	
DN3 1/8"	0.9	---	---	290685	---	---	1/4" NPSM (F/M)
	0.9	291004	---	---	---	---	1/4" NPSM (F/M)
DN5 3/16"	1.5	316-506	---	---	---	---	1/4" NPSM (F/M)
	2.7	550-222	---	---	---	---	1/4" NPSM (F/M)
	7.6	291007	---	---	---	---	1/4" NPSM (FBE)
	15.2	291008	---	---	---	---	1/4" NPSM (FBE)
DN6 1/4"	0.9	---	---	2389428	2389440	2389450	1/4" NPSM (FBE)
	1.8	316-533*	---	2389430	2389442	2389452	1/4" NPSM (FBE)
	1.8	550-227	---	---	---	---	1/4" NPSM (F/M)
	7.6	316-513	---	---	---	---	1/4" NPSM (FBE)
	15.2	316-505	286498	2389429	2389441	2389451	1/4" NPSM (FBE)
DN10 3/8"	30.5	---	---	2389427	2389439	2389449	1/4" NPSM (FBE)
	1.8	---	---	2389436	2389446	2389456	3/8" NPSM (FBE)
	7.6	508342	---	---	---	---	3/8" NPSM (FBE)
	15.2	291006	286499	2389434	2389445	2389455	3/8" NPSM (FBE)
DN13 1/2"	30.5	---	---	2389432	2389444	2389453	3/8" NPSM (FBE)
	7.6	225-112*	---	---	---	---	1/2" NPSM (FBE)
	15.2	250-112*	---	2389425	2389438	2389448	1/2" NPSM (FBE)
DN19 3/4"	30.5	---	---	2389424	2389437	2389447	1/2" NPSM (FBE)
	15.2	---	---	---	2389443	2426010	3/4" NPSM (FBE)

*Textile Braid. Spring guards at both ends.

FBE Female Both Ends, **NPT** National Pipe Tapered Thread, **NPSM** National Pipe Straight Mechanical Thread, **MBE** Male Both Ends, **F/M** 1 Female / 1 Male Connection



HOSE SHIELD

Protect your airless hose from paint and abrasion damage with a durable four-mil poly hose cover. Comes in 230 m lengths with perforations every 1.5 m to fit any length of hose. Works with 1/4" and 3/8" hoses.

Hose sold separately.

	PART-NO.
Hose Shield	0521424



MOISTURE RESISTANT HOSE

	PART-NO.
3/8" x 517 bar x 15 m	375750050ML
1/2" x 517 bar x 15 m	500750050ML
3/4" x 517 bar x 15 m	2426011
3/4" x 69 bar Transfer hose	750100012R



REEL-EZ HOSE REELS

Eliminate hose hassles while increasing your production. Both models mount to most major manufacturers' paint sprayers with similar designs.

- ▶ The 40 cm Cart-Mount holds up to 100' (30.5 m) of 1/4" airless hose
- ▶ The 25 cm Skid-Mount holds up to 50' (15.2 m) of 1/4" airless hose
- ▶ Pressure rated at 248 bar (24.8 MPa)

Fits handles/carts 3/4" to 1-1/2" in diameter.

	PART-NO.
40 cm Cart-Mount	769-100
25 cm Skid-Mount	769-200



AIR-ASSISTED AIRLESS SPRAY HOSES

	PART-NO.
3/16" x 7.5 m Bonded Fluid Hose	9984595
1/4" x 15 m Bonded Fluid Hose	0524333
1.5 m Fluid Whip Hose	0550861



HIGH PRESSURE SWIVELS

- Decreases resistance while spraying reducing overall fatigue
- Reduces hose kinking
- Pressure rated at 345 bar (34.5 MPa)

	ART.NR
Gun-to-Hose / Hose-to-Pump 1/4" (0.63 cm) NPS (F) x 1/4" (0.63 cm) NPS (M)	0509985
Hose-to-Hose 1/4" (0.63 cm) NPS (M) x 1/4" (0.63 cm) NPS (M)	0502135



HIGH PRESSURE FLUID GAUGE KIT

Includes: 345 bar (34.5 MPa) high pressure fluid gauge attached to a T-Fitting with one 1/4" (M)(.63cm) fitting & one 1/4" (F)(.63cm) fitting.

HEA PRESSURE GAUGE

Maximize the performance of your TR¹ HEA Tips.

	PART-NO.
High Pressure Fluid Gauge Kit	0508239
Fluid Gauge Only	0508626
HEA Pressure Gauge	0580495

SPRAYROLLER

- Designed to spray and back roll in one motion.
One person doing the work of two employees
- Reduces overspray decreasing Prep work
- Professional finish from a new/novice applicator
- Provides consistent mil thickness on textured surfaces
- Gives a roller finish; easier to touch-up
- Modular design
- Attaches to the TITAN SprayGuide swivel
- Uses any standard roller cover
- Designed to be used with all airless sprayers and extension poles
- Quick tool-free changeover for the complete wall system

SPRAYGUIDE

Exclusive CUT-IN tool

- No more taping, no more ladders
- Perfect for windows, doors and roof lines



	PART-NO.
SprayRoller (no tip)	2403780
SprayRoller Combo Kit*	2403959
SprayRoller Combo Kit* with 0.9 m Pole	2404013

*Combo Kit includes: 9" SprayRoller, SprayGuide, TR¹ 415 Reversible Tip & Swivel Head Assembly



SprayRoller Head
with TR¹ Tip



INNER-FEED ROLLER

Roll non-stop until the job is done

- Up to four times faster than standard rolling
- Never take the roller off the wall to go back to the tray; when the roller starts to get dry, simply pull the trigger to wet roller cover
- Never have to worry about dry edges
- More consistent mil thickness
- Designed to be used with all airless sprayers and any brand of extension pole

	PART-NO.
Inner-feed Roller Head	2404 445

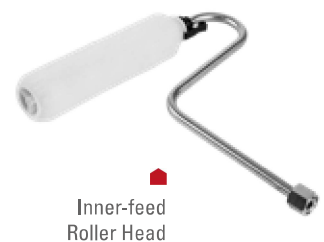

Inner-feed
Roller Head

HOSE CONNECTOR / DOUBLE CONNECTOR

Spraying is more than just hooking up a hose. Sometimes the situation calls for extending hose length or altering the angle of the hose connected to the sprayer. That's when you need TITAN manifolds and

fittings. Our fittings are manufactured from quality carbon steel and plated for maximum corrosion resistance.

COUPLINGS

		NPS (M)				NPT				
		1/4"	3/8"	1/2"	3/4"	1/8"	1/4"	3/8"	1/2"	3/4"
NPS (M)	1/4"	5045	812-003			490-001	227-006	804-555	814-003	
	3/8"		490-014				812-003	808-555	815-005	
	1/2"			449-621			228-002			814-555
	3/4"									
NPT	1/4"						490-002	490-006		
	3/8"							814-004	814-005	
	1/2"								814-006	101-201
	3/4"									814-007



INFO: NPS (M) AND NPT ARE COMPATIBLE.

Maximum Working Pressure: 345 bar (34.5 MPa)

- NPSM
Hose to Hose
- Manifold to
hose
- Manifold to
manifold

COUPLINGS HIGH PRESSURE HOSE TO HOSE

		NPS (M)				NPTF				
		1/4"	3/8"	1/2"	3/4"	1/8"	1/4"	3/8"	1/2"	3/4"
NPS (M)	1/4"	367560	367561							
	3/8"									
	1/2"									
	3/4"		9985783	9985782	9985781					
NPTF	1/4"									
	3/8"						9885646	9885643		
	1/2"						9885644	9885647	9885648	
	3/4"									



INFO: NPS (M) AND NPT ARE COMPATIBLE.

Maximum Working Pressure: 517 bar (51.7 MPa)

- NPSM
Hose to Hose
- Manifold to
hose

ADAPTER



		INNER						
		NPS (M)			M	G		
		1/4"	3/8"	1/2"	M16 X 1,5	G 1/4"	G 3/8"	G 1/2"
OUTER	NPS (M)	1/4"	2325928	2325929*	97201	2332619	2332621	
		3/8"	179732	2325930**	97204		2332620	2332623***
		1/2"	2302993					
	M	M16 X 1,5	34041	367563			115378	
		M20 X 2			118231			
	G	G 1/4"	179247					
		G 3/8"			377342	2353265		
		G 1/2"			349256			

* HC 1/2" auf 1/4" (Emulsion) ** HC 1/2" auf 3/8" (Plaster)

90° STREET ELBOWS



	PART-NO.
3/8" NPT(F) x 3/8" NPT(M)	818-002
1/2" NPT(F) x 1/2" NPT(M)	818-003
3/4" NPT(F) x 3/4" NPT(M)	818-010
Maximum Working Pressure: 345 bar (34.5 MPa)	

REDUCER BUSHINGS



	PART-NO.
3/8" NPT(M) x 1/4" NPT(F)	817-001
1/2" NPT(M) x 1/4" NPT(F)	929-061
1/2" NPT(M) x 3/8" NPT(F)	541-009
3/4" NPT(M) x 1/4" NPT(F)	929-062
1" NPT(M) x 3/4" NPT(F)	929-076
1-1/4" NPT(M) x 1" NPT(F)	929-077
Maximum Working Pressure: 345 bar (34.5 MPa)	

PIPE TEES



	PART-NO.
1/4" NPT(F)	970-023
3/8" NPT(F)	817-002
1/2" NPT(F)	817-003
3/4" NPT(F)	817-004
Maximum Working Pressure: 345 bar (34.5 MPa)	

SWIVEL UNIONS



	PART-NO.
1/4" NPS(F) x 1/4" NPT(M)	490-005
3/8" NPS(F) x 1/4" NPT(M)	490-042
1/4" NPS(F) x 3/8" NPT(M)	490-032
3/8" NPS(F) x 3/8" NPT(M)	490-043
1/2" NPS(F) x 1/2" NPT(M)	200-555
3/4" NPS(F) x 3/4" NPT(M)	138-037
1" NPS(F) x 1" NPT(M)	200-556
Maximum Working Pressure: 345 bar (34.5 MPa)	

PIPE PLUGS



	PART-NO.
1/4" NPT(M)	227-027
3/8" NPT(M)	227-033
1/2" NPT(M)	210-023
3/4" NPT(M)	210-038
Maximum Working Pressure: 345 bar (34.5 MPa)	

MULTIPLE GUN ADD-ON ASSEMBLIE

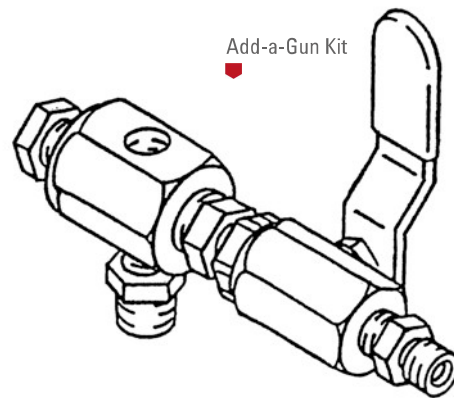
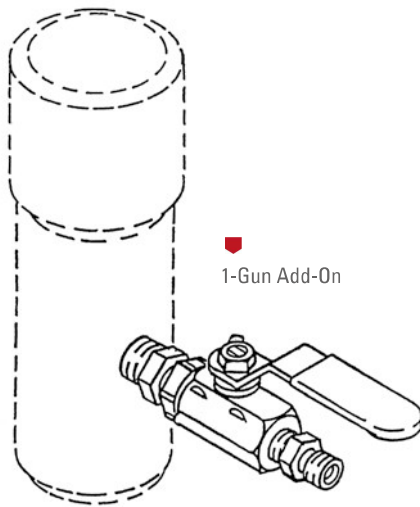

MULTIPLE GUN ADD-ON ASSEMBLIES (1/4")

Hose connection 1/4" MPSM (M).

	975-212 2-GUNS	975-213 3-GUNS
INCLUDES	QTY.	QTY.
1-Gun Add-On (975-111)	1	1
Add-A-Gun-Kit (975-200)	1	2
Maximum Working Pressure: 248 bar (24.8 MPa)		

MULTIPLE GUN ADD-ON ASSEMBLIES (3/8")

Hose connection 3/8" NPSM (M).

	975-312 2-GUNS	975-313 3-GUNS	975-314 4-GUNS
INCLUDES	QTY.	QTY.	QTY.
1-Gun Add-On (975-311)	1	1	1
Add-A-Gun Kit (975-300)	1	2	3
Maximum Working Pressure: 248 bar (24.8 MPa)			

HIGH PRESSURE BALL VALVE

FITTING SIZE		PART-NO.
1/4"	414 bar (41.4 MPa)	0533358
1/4"	517 bar (51.7 MPa)	0533348
3/8"	414 bar (41.4 MPa)	0533359
3/8"	517 bar (51.7 MPa)	0533347

GUN ADD-ON KITS:

Can be used on pumps with an open 3/8" NPT port on the manifold.

	1-GUN ADD-ON		ADD-A-GUN	
	975-111 1/4" Hose	975-311 3/8" Hose	975-200 1/4" Hose	975-300 3/8" Hose
INCLUDES	PART-NO.	PART-NO.	PART-NO.	PART-NO.
Nippel, Hex	814-002	814-004	814-002	814-004
Ball Valve	940-553	941-555	940-553	941-555
Nippel, Hex	227-006	808-555	227-006	808-555
Plug, Pipe			227-033	227-033
Block, Mani-fold			970-100	970-100
Nippel, Hex			814-004	814-004

Maximum Working Pressure: 248 bar (24.8 MPa)

THERMCONTROL

TITAN ThermControl units feature an integrated electric heating element within the hose, allowing the material to heat as it passes through. The temperature can be easily adjusted between 20°C and 60°C, enabling precise control based on the application. This ensures that the applicator can always spray at the

optimal working temperature, regardless of seasonal changes. Heating the material reduces its viscosity, offering several advantages: no need to dilute thick coatings, improved handling of high-viscosity materials, reduced overspray, and overall better spraying performance.



THERMCONTROL EASY

The ThermControl easy material heating hose is particularly small and compact and ideal for paint processing using the airless method. Equipped with a lightweight 10 m stainless steel hose, it can be easily connected to airless diaphragm and piston pumps.

- Spray with excellent surface quality the S3 Gun is robust and has a long service life
- Flexible and robust 10 m long DN6 stainless steel hose
- Clearly laid-out control unit the required temperature can be fully adjusted from 20° C to 60° C as needed by pressing the arrow buttons.

THERMCONTROL ADVANCED

The ThermControl advanced material heating hose is the ideal accessory for applying emulsion and latex paints in conjunction with airless devices. The practical hose reel on a cart makes the heated hose easy to handle and is suitable for use on construction sites.

- Spray with excellent surface quality the S3 Gun is robust and has a long service life
- Flexible and robust 15 m long DN6 stainless steel hose
- Perfect surface finish with TempSpray heating of the coating material produces a soft spray pattern and therefore perfect atomization. Other advantages include less overspray, perfect viscosity without dilution and much more

SPECIFICATIONS	THERMCONTROL EASY
Voltage	230 V / 50 Hz
Motor output	0.6 kW
Operating pressure, max.	250 bar, 25 MPa
Temperature controller	20 - 60 °C
Hose length	10 m
Viscosity, max.	5.000 mPas
Mains connection cable	4 m

Scope of delivery ThemControl easy base unit, S-3 Gun & 410 Tip; gun filter red

PART-NO. 2312712

SPECIFICATIONS	THERMCONTROL ADVANCED
Voltage	230 V / 50 Hz
Motor output	1.3 kW
Operating pressure, max.	250 bar, 25 MPa
Temperature controller	20 - 60 °C
Hose length	15 m
Viscosity, max.	25.000 mPas
Mains connection cable	46 m

Scope of delivery ThemControl advanced base unit, S-3 Gun & 419 Tip; gun filter red

PART-NO. 2312713

OUR PRODUCT HIGHLIGHTS

- minimal overspray
- constant paint viscosity even with variable outside temperatures
- excellent spraying pattern
- reduce of solvents due to reduction in viscosity
- film thickness can be increased
- optimal surface quality thanks to a very soft spray jet
- we advise to use the units in combination with a S3 gun
- both units contain a full three years guarantee
- adaptable to most TITAN airless units

CHANGE IN VISCOSITY DUE TO HEATING

The heating of the material leads to a drop in viscosity. The optimal viscosity along with the right working technique and equipment is important for a good result when spraying. If the material is too thick the result is an irregular spray pattern and a poor fan pattern.

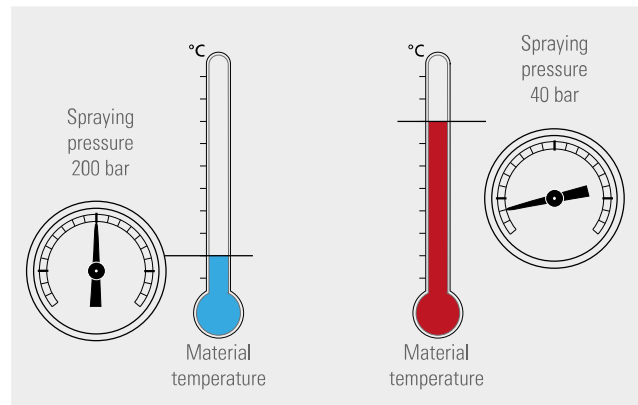

THERMCONTROL – HOW IT WORKS

All ThermControl units have an electric heating element, which is located inside the hose. Due to this, the material is heated by passing through the hose. The temperature can be easily regulated from 20° C to 60° C. So you can set the material temperature variably depending on the application. And you can always spray at the ideal working temperature regardless of seasonal temperature fluctuations. Furthermore, the heating brings about a reduction of the material viscosity, which has a lot of positive effects: No diluting of the coating material necessary, ideal for high-viscosity materials, less overspray and much more. Your answer to the VOC guidelines!

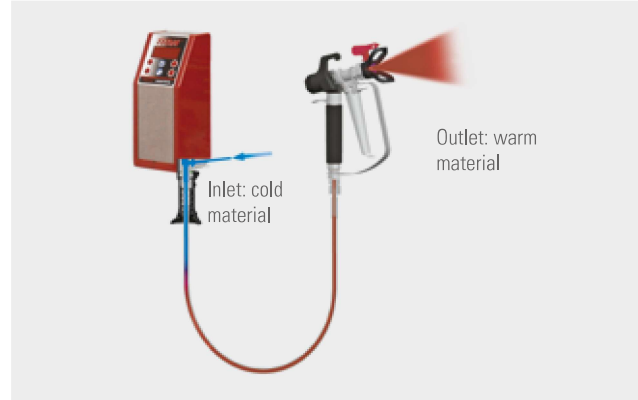

SUCTION SYSTEM FOR HYDRA X

	PART-NO.
Flexible Tote Suction System	2410501
Flexible suction hose, 2 m, 2" NPT threaded connection, for standard and large volume containers	2426206
Rigid suction system, with filter basket, for 250 l open barrel	2402315A
Closed Drum Sealed Suction System	2426217
Rigid suction system, with filter basket, for 20 l bucket	2410501A
Closed Drum Sealed Suction System	2426217

CONVERSION KIT FOR HYDRA X

	PART-NO.
Hydra X 4540 to 7230 Conversion Kit	2424618
Hydra X 7230 to 4540 Conversion Kit	2432905A

Note: Converting the 4540 to the 7230 will change the fluid section pressure to 6900 psi. Converting the 7230 to the 4540 will change the fluid section pressure to 4650 psi.

HOPPER

Perfect for small volumes of paint

	PART-NO.
Hopper 3.7 litre (for Elite 2000)	2463293
Hopper 5 litre	341267
Hopper 20 litre	341266

SUCTION SYSTEMS

	PART-NO.
Large volume containers	2312715
Container Connector (for Elite 4500, PowrBeast, PowrTwin)	2371930
Container suction system, incl. C-couplin adapter for PowrTwin	349907



LINESTRIPER ACCESSORIES

Ideal for all PowrLiner sprayers.



LAZYLINER ELITE

- ◆ 200-Watt lamp coil charging system
- ◆ Engine protection bumper bar
- ◆ Heavy-duty pneumatic tyres (16" x 6.5")
- ◆ Multi-position seat (forward/back, side to side)
- ◆ Height adjustable foot pedals
- ◆ Compatible with PowrLiner 2850–8955

LAZYLINER PRO

- ◆ Standard pneumatic tyres (16" x 4.5")
- ◆ Multi-position seat (forward/back, side to side)
- ◆ Height adjustable foot pedals
- ◆ Compatible with PowrLiner 2850–8955

SPECIFICATIONS	LAZYLINER ELITE	LAZYLINER PRO
Engine - Petrol	Honda GX 200 Electric or Pull Start	Honda GX160 Pull Start
Start	Pull or Electric	Pull
Speed - Forward	0 – 19 km/h	0 – 19 km/h
Speed - Reverse	0 – 11 km/h	0 – 11 km/h
Bumper / Engine Protection Bar	Included	sold separately - 0290646Z
PART NO.	0290040H	0290041H

LINE STRIPING - USEFUL ACCESSORIES



WindGuard Spray Shield

WINDGUARD SPRAY SHIELD

Spray shield protects spray pattern from wind, minimizing over-spray. Works well when applying diluted athletic field marking paints. Adjustable for easy "on the fly" line width changes – (10, 15 or 20 cm) and is easily removed from sprayer.

- Attaches to any TITAN PowrLiner and most competitive models
- Spring loaded shields promote forgiveness on uneven surfaces
- Lightweight – only 2.5 kg

Handibead Glass Bead Dispenser



HANDBEAD GLASS BEAD DISPENSER

Apply glass beads with consistency and accuracy. Eliminates hand tossing glass beads on stop bar or crosswalk applications.

- Adjustable diffuser can disperse material up to 38 cm wide
- Includes 3 nozzles (small, medium and large)



Second Gun Kit



SECOND GUN KIT

These gun kits come complete with mounting bracket, airless gun, 1.8 m x ¼" hose and line striping tip. Mounts on either side of 4950, 6950 and 8950 PowrLiner.

	PART NO.
RX-80 Gun Kit with manifold and pressure gauge (only for PL3500)	2422269
S-3 Gun Kit	759-138
S-5 Gun Kit	759-038



GLASS BEAD DISPENSING SYSTEMS

Includes hopper, hose and dispenser.

	PART NO.
1-Gun Kit (10 - 15 cm)	424-826
2-Gun Kit (10 - 15 cm)	424-836
1-Gun Kit (30 cm)	424-840
2-Gun Kit (30 cm)	424-841
Add a Second Dispenser to your 1-Gun Kit Second Dispenser with Hose (10 - 15 cm)	424-816

Compatible with: 4950, 4955, 6950, 6955, 8950, 8955, 4900XLT, 6900XLT and 8900XLT. LazyLiner and PowrLiner sold separately.



LINELASER KIT

100 m green LineLaser for clear visibility even in daylight conditions. Strong magnetic mount for individual fixation on all PowrLiner units.

- Can be powered with 12 V outlet on PL 6955 / 8955 models or with any 5 V powerbank (not included)
- Magnetic mount with tiltable arm to fixate the laser module in every position and angle needed
- Easy and fast installation and removal

PART NO.

LineLaser Kit	2436953
---------------	---------

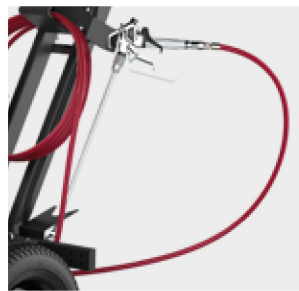

STENCIL KIT POWRLINER 3500

Ideal setup for easy and fast stenciling work.

- Second gun with tip extension is stored securely for direct access
- Manifold with separate valves and a pressure gauge allows separate control over both guns
- 2-piece mounting bracket with gun hook and anti-drip tray

PART NO.

Stencil Kit	2418165
-------------	---------

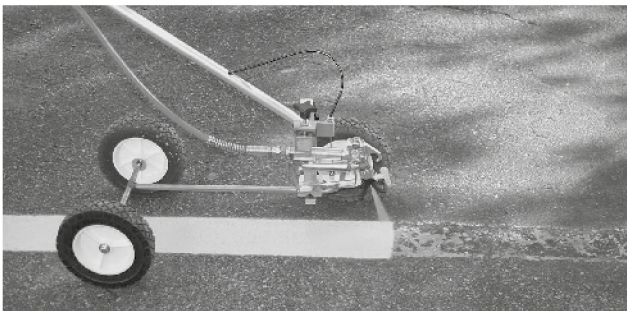

SIDESTRIPER

Handheld marking arm. Extremely flexible and versatile for markings in confined areas.

- Perfect in use with RX-80 or S-3 marking gun
- Trigger extension for working in an upright position

PART NO.

SideStriper	759-150
-------------	---------



■ Honda Lithium-ion Battery



■ Honda Lithium-ion Battery Charger (EU-Plug)

BATTERY ACCESSORIES FOR POWRLINER 3500 72V

- Removable battery means no plugging the sprayer into an outlet
- Swappable battery means no down time in the field (second battery sold separately)
- Less than one hour recharge time

ART.NR

Honda Lithium-ion Battery	2445452
Honda Lithium-ion Battery Charger (EU-Plug)	2445453E

SURETRAK FLOATING GUN KIT

Keeps the gun at the proper height from the surface for perfect lines over rough terrain.

- ▶ Works great on pavement, grass and turf
- ▶ Attaches to PowrLiner 4950, 4955, 6950, 6955, 8950 and 8955

	PART NO.
SureTrak Floating Gun Kit	759-120



SureTrak Floating Gun Kit

LAZYLINER TRAY

Use this attachable tray system as an option for carrying around additional items.

- ▶ For use on the LazyLiner Pro and Elite

	PART NO.
LazyLiner Pro Tray (must be added bumper 0290646Z)	0290645Z
LazyLiner Elite Tray	2413480



LazyLiner Tray



SMARTARM ASSEMBLY

Built to make line adjustments and transportation quick and easy.

- ▶ Pivots down for spraying and up for transportation/storage
- ▶ Locks in at any angle for curb striping
- ▶ Adjust gun height (fan pattern) up/down with the turn of a lever
- ▶ Automatically centers spray arm for easy set-up
- ▶ Graduated to return to your preferred spray position

	PART NO.
SmartArm Assembly	0290382

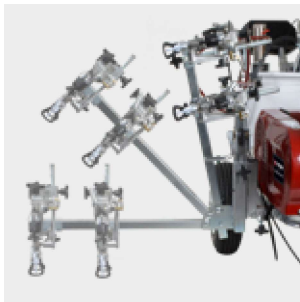

SmartArm Pivot System



SmartArm Lift System

CLEANING AND SERVICE FLUIDS

	PART NO.
Piston lube 120 ml	314-481
Piston lube 240 ml	314-480
Piston lube 940 ml	700-926
Coolflo hydraulic oil 940 ml	430-362
Coolflo hydraulic oil 3780 ml	430-361
LS-10 Liquid Shield Plus 940 ml	2412657
PumpShield 350 ml	297055



STRIPER ADD-ON ACCESSORIES

RECOMMENDED GUNS	PART NO.
RX 80 (2-Finger-Grip; incl. tip)	0538008
RX 80 (4-Finger-Grip; incl. tip)	0538007
RX Pro (2-Finger-Grip; incl. tip)	0538022
S-3 Gun, incl. tip	0550060

UPGRADES	PART NO.
45-Litres Hopper	759-130
Polyethylene 19-Litre Pail Cover	759-147
Turf Kit for PowrLiners 4955–8955	759-155
Cleaning Kit	10-500-P
PointerLine Visor	424-620
Hopper for PL 3500	0341267
20-Litres Hopper	0341266

LAZYLINER HITCHES	PART NO.
PowrLiner 2850	0290043Z
PowrLiner 3500 4500 hitch kit	537935
PowrLiner 4950/6950/8950, 4955/6955/8955, 4900/6900/8900xlt hitch kit	2430599
XLT models only: add updated axle with pre-drilled mounting holes	0290489A

The drivers are not shipped with a hitch; use chart to identify which hitch to order.



ENGINEERED FOR PERFECT LINES



THE INDUSTRY'S BEST PERFORMING FAN PATTERN

- Sprays razor sharp lines
- Consistent line width from the first litre to the last

LONGEST LASTING STRIPING TIP IN THE MARKET

- Uniform film build for the life of the tip
- Less wasted paint equals more profit

NEW EASY-TO-READ TIP SIZES

- 421= 4" (10 cm) wide line (at 15 cm above the surface) with a 0.021" (0.533 mm) orifice



ORDER THE RIGHT TIP
Insert the Tip size

TIP SIZE
697- XXX

WHICH TIP DO I USE FOR WHICH JOB?

	SPORT FIELD LINES	ROAD LINES						CURB LINES	STOP OR CROSS WALK
DIMENSION CM	6	10	12	15/18	20 22,5	25 30	37,5	20	50
LOW VISCOSITY	213 ● 215 ●	417 ○		619 ○	619 ○ 621 ○	821 ○ 823 ●	825 ● 827 ●	2 x 621 ○	2 x 627 ●
HIGH VISCOSITY	217 ○ 219 ○	419 ○ 421 ○		619 ○ 621 ○	621 ○ 623 ●	825 ● 827 ● 829 ●	831 ● 835 ●	2 x 623 ●	2 x 631 ●

The indicated line widths are based on a distance of 15 cm between tip and surface.

To increase line widths e.g. 30 and 37.5 cm, extend the distance between tip and surface (lift up the gun).

Sort of filter ● ● ○ ●



SC-6+
Reversible Tip



TR1 Line
Striping Tip



SC-6+ TIPS STENCILING. 662-XXX

		ORIFICE SIZE (INCHES)																						
		INCHES	MM	.007	.009	.011	.013	.015	.017	.019	.021	.023	.025	.027	.029	.031	.033	.035	.039	.043	.045	.051	.055	
FAN PATTERN WIDTH	2-4	51-102	107	109	111	113	115	117																
	4-6	102-152	207	209	211	213	215	217	219	221	223	225	227	229	231	233	235							
	6-8	152-203	307	309	311	313	315	317	319	321	323	325	327	329	331	333	335							
	8-10	203-254	407	409	411	413	415	417	419	421	423	425	427	429	431	433	435	439	443	445	451	455		
	10-12	254-305		509	511	513	515	517	519	521	523	525	527	529	531	533	535	539	543	545	551	555		
	12-14	305-356		609	611	613	615	617	619	621	623	625	627	629	631	633	635	639	643	645	651	655		
	14-16	356-406							719	721					731	735								
16-18	406-457								821						831									
	Flow (l/min)	---	0.19	0.34	0.45	0.68	0.91	1.17	1.47	1.78	2.15	2.53	2.95	3.44	3.89	4.42	4.99	6.20	7.52	8.24	10.58	12.32		

Maximum Working Pressure: 344 bar

TR1 LINE STRIPING TIPS 697-XXX

		ORIFICE SIZE (INCHES)														
		INCHES	MM	.013	.015	.017	.019	.021	.023	.025	.027	.029	.031	.035	.039	.043
FAN PATTERN WIDTH	2	51		213	215	217	219									
	4	102		413	415	417	419	421	423	425	427	429	431	435	439	443
	6	152			615	617	619	621	623	625	627	629	631	635	639	643
	8-10	203-254						821	823	825	827	829	831	835	839	843
	Flow (l/min)	---		0.68	0.91	1.17	1.47	1.78	2.15	2.53	2.95	3.44	3.89	4.99	6.20	7.52

Maximum Working Pressure: 344 bar



TIP GUARD

UNTHREADED	
TIP GUARD	PART NO.
No build Guard	0289228



GUN FILTERS

For use with RX-Pro, RX-80, G-10, LX-30, LX-40, LX-50, LX-70.

UNTHREADED		
FILTERS	BULK PART NO.	2-PACK PART NO.
Coarse (Green)	581-059	0089957
Medium (White)	581-060	0089958
Fine (Yellow)	581-062	0089959
Extra Fine (Red)	581-061	0089960

CLEANING AND CARE PRODUCTS

No matter what the sprayer – hydraulic, gear-driven, petrol-powered or electric – if you want a long service life you will need to care for it with the same attention you care for your own car or truck. That means changing the oil, lubricating the piston, cleaning the unit, the gun and

PUMPRUNNER

PumpRunner prevents the inlet valve from drying out, ensures clean transport and reduces clean up time. Works on most high rider model sprayers.

Sprayer sold separately.



	PART-NO.
PumpRunner	0286008

LS-10 LIQUID SHIELD PLUS

Cleans and protects your spray system against rust and corrosion, extending the life of your pump.

► Includes anti-freeze protection



	PART-NO.
940 ml Bottle	2412657

PUMP SHIELD

Cover your sprayer to prevent paint overspray from sticking to it. Keeps your sprayer looking like new.

	PART-NO.
Pump Shield	0297055

PISTON LUBE

Specially formulated to prevent materials from adhering to the piston rod. Suitable for use with most airless piston pumps and Helix.



	PART-NO.
120 ml Bottle	314-481
240 ml Bottle	314-480
940 ml Bottle	700-926

the tip. TITAN has all the products you need to keep your accessories and equipment clean and functioning in top condition.

PAINT MATE

Water-based coating additive that significantly improves atomization with HVLP sprayers without compromising the integrity of the coating.

	PART-NO.
940 ml Bottle	0508071

AIR CARE

Pneumatic equipment lubricant storage protector. Contains premium additives to extend life of equipment. 950 ml Bottle

	PART-NO.
940 ml Bottle	311-101

COOLFLO

Hydraulic Fluid for PowrTwin, Hydra and sealed hydraulic sprayers.

	PART-NO.
940 ml Bottle	430-362
3.78 l Bottle	430-361

PART RENU

Safely remove paint from spray guns and sprayer accessories. This nonflammable, water-based cleaner is environmentally safe, odor free and will not burn skin. Easily washes off with water.

► Starter Kit includes easy-to-use strainer

	PART-NO.
3.78 l Part Renu	0521423
18.92 l Starter Kit	0521010

NOTES

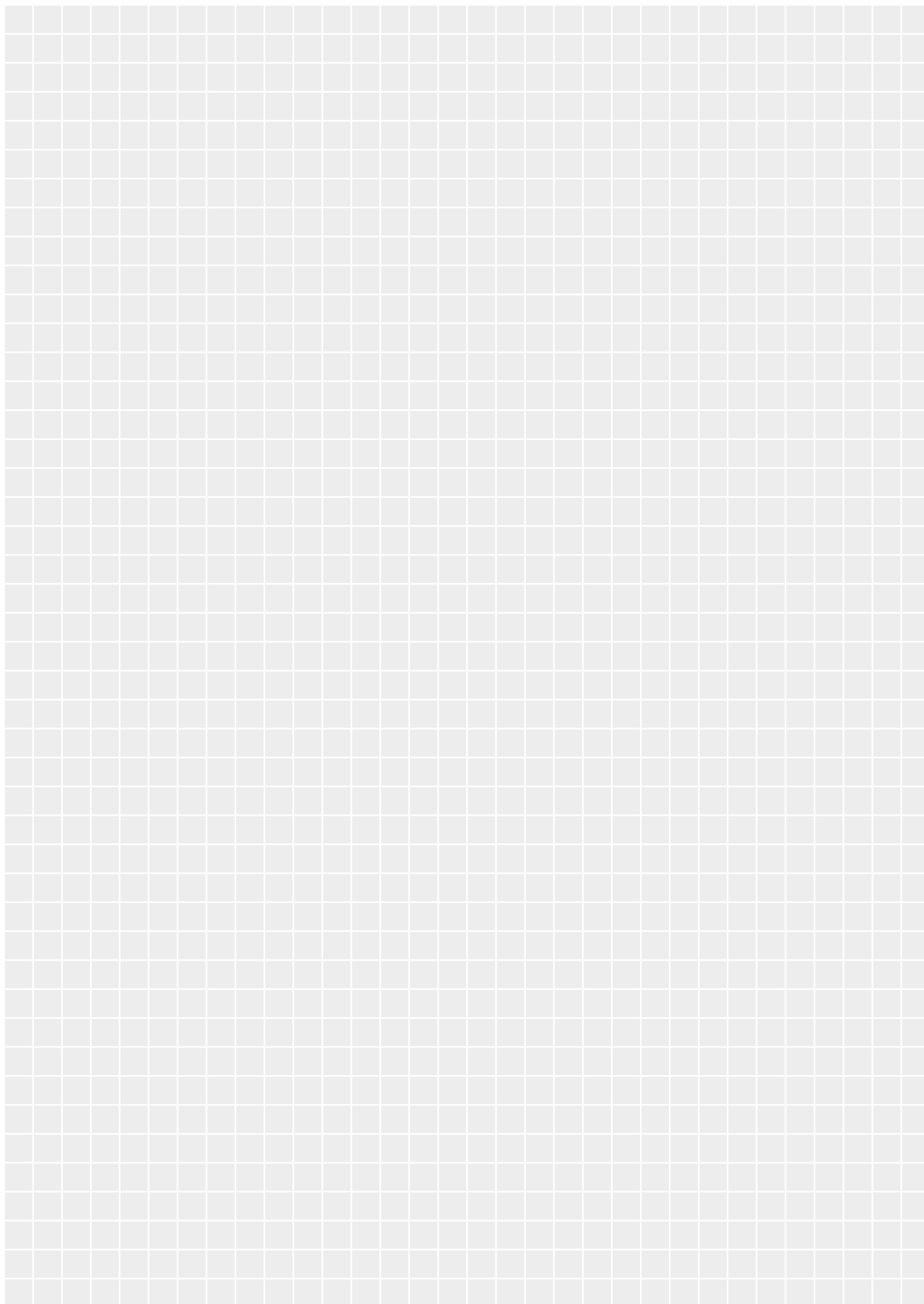



Sold exclusively through professional distributors
Visit us at: titantool-international.com



All information contained in this brochure is based on the latest information available at the time of printing. TITAN reserves the right to make changes at any time, without notice. Due to continuous innovation, specifications may progressively change. Contact one of our dependable sales reps or call our dedicated customer service team for more information. Current general terms and conditions of the WAGNER-Group can be found on www.wagner-group.com.

J. Wagner GmbH | Otto-Lilienthal-Str. 18 | 88677 Markdorf | Customer.Service-PF@wagner-group.com | titantool-international.com